

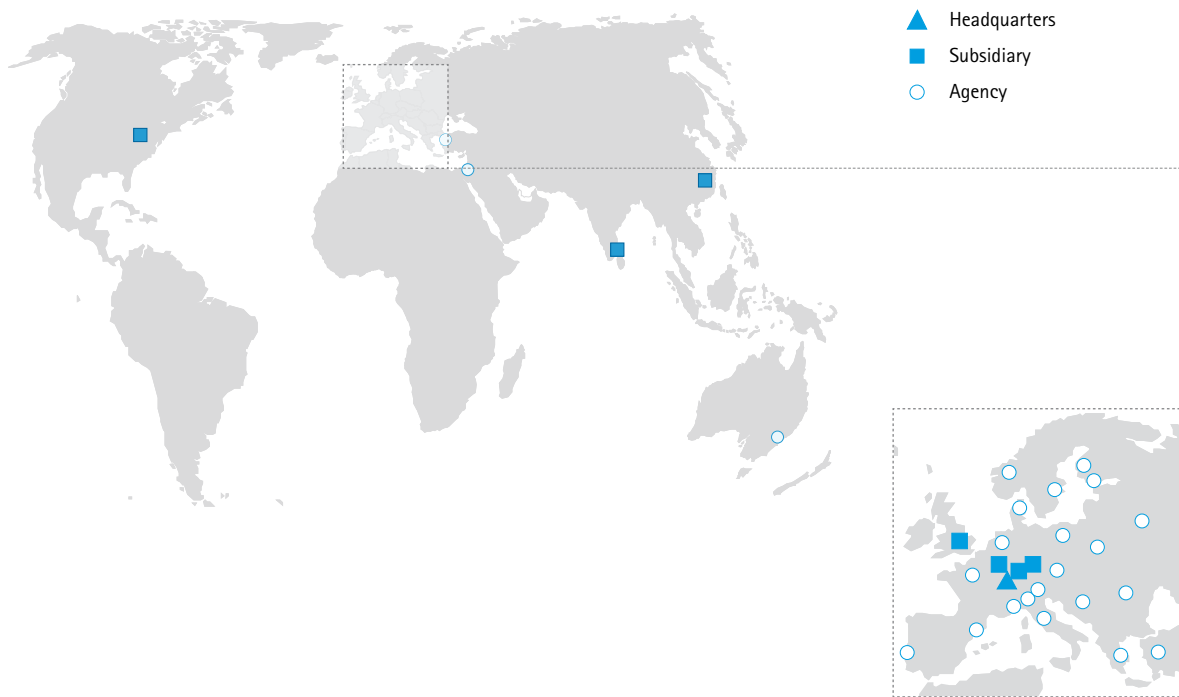

## Lockline Gas Springs

Varilock – Lockable gas springs and accessories



## SUSPA – Your strong industrial partner

For more than 50 years, SUSPA products have been present in your daily life – at home in furniture, refrigerators and washing machines, in means of transport like buses, trains and planes, in modern office furniture, in leisure and fitness equipment, but also in hospital beds and operating tables in hospitals and rehab centers.

Although you may not be able to see our products, we are always there – increasing the comfort and safety level for all of you. Major players in the automobile, office furniture, industrial, transportation, appliance, health care, leisure, and gaming industries depend on SUSPA as a developmental and systems solution partner. Our engineers and technical sales team will work seamlessly with your staff on a wide variety of projects, committed to providing the most effective solution for your organization.

SUSPA's worldwide sales and distribution network allows us to always be in touch with our customers – no matter where they are in the world! SUSPA also has production facilities in Germany, China, India, the Czech Republic, and the United States. This worldwide manufacturing capability gives SUSPA and SUSPA companies: competitive edge over other gas spring manufacturers.

## Reliability as highest standard

Requirements on quality are increasing in the automotive industry as well as in other industry sectors. SUSPA certifications according to TS16949 have therefore been an integral part for quite some time.

Effective quality management from purchasing to production and sales and on to final application secures the worldwide great reputation and reliability of SUSPA gas springs.

We test gas springs 100% according to our internal quality standard. Without any maintenance required, SUSPA gas springs normally achieve a service life of over 50,000 load cycles. This represents, on average, 10 years of use in the automotive area for the movement of the boot lid and tailgate or 20 years of use for a roof window.

# Contents

Design, functionality and features	4-5
Basic range: technical data	6-7
<a href="#">Elastic locking, rigid locking</a>	
Special functions	8-9
<a href="#">AntiShock, EasySwitch, OverRide, TimeReset, ComfortRelease</a>	
Release Systems	10-11
<a href="#">Release mechanism, bowden cables and release levers</a>	
End fittings	12
<a href="#">Joint eyelets and fork heads</a>	
SUSPA expertise in system solutions	13-15
<a href="#">Components, height-adjustable table columns VariStand and VariBase</a>	
Areas of application and client references	16-17
SUSPA - Your development partner	18
Technical advice	19



[www.suspa.com/uk/products/locking-gas-springs](http://www.suspa.com/uk/products/locking-gas-springs)

# Design and functionality of lockable gas springs

## The Varilock working principle

Gas springs are hydropneumatic adjustment components. They consist of a gas pressurized tube together with a piston rod and piston. The piston is fitted with a valve that is actuated by the release pin. When the valve is shut, the gas spring does not move, thus providing locking in the desired position. Depending on the pressure medium, this locking feature can be either rigid or elastic.

The locking behavior of the EL1 and EL2 gas springs are elastic in both extension and compression. This is achieved by filling the gas spring with compressible nitrogen.

The rigid-locking HY1, HY3, HY4, HY6 and VOB18-1 gas springs have separated gas and oil chambers. Depending on the arrangement of these chambers, locking behavior will be rigid in either the compression or extension direction.

SUSPA's engineering know-how comes into its own in the valve design. High precision mechanics are used to implement a wide variety of special functions *(see pages 8 and 9 for details)*. The end result is not just a gas spring, but an intelligent system that constitutes a tremendous amount of added value to a customer's application.

## Forces

The gas spring's extension force depends on the filling pressure. When the Varilock is being manufactured, the force is set at the nominal value  $F_1$  and remains unchanged over the service life of the gas spring. The locking feature is released when the Varilock's valve is opened. This is a result of the user applying an activation force on the release pin. Once the user lets off the control element, the internal gas pressure causes a resetting force closing the valve again automatically. The actuation force and the resetting force both depend on the filling pressure of the gas spring and are proportional to the Varilock's extension force.

## Type of locking

Rigid locking in extension (Varilock HY1 and HY3) is used when a cushioning effect in the locking position is not desired – for example, for safety reasons. Rigid locking in compression (Varilock HY4, HY6 and VOB18-1) is recommended for light weight applications that are subject to high compression forces when locked and require no movement. The VOB18-1 and HY6 are ideal for applications that require a short installation length and a large stroke *(see page 7 for details)*.

Elastic-locking gas springs Varilock EL1 and EL2 are recommended when the locking feature is required to have a cushioning effect. Sudden jolted loads can thus be dampened or even completely avoided *(see page 6 for details)*.



# Features of lockable gas springs

## Spring characteristic curve

As the graphic illustration indicates, the spring characteristic curve represents the force curve of the gas spring over the stroke, from the extended to the retracted state. The progression thereby represents the force ratio  $F_2/F_1$  in extension direction. To be able to dimension a gas spring, force  $F_1$ , apart from the dimensions, is an important measuring criterion. Force  $F_1$  is measured 2 mm (0.08 in)

from the end of the extension movement and defines the value of the spring force. Force  $F_R$ , resulting from friction, develops between the force lines in the direction of retraction and extension. The extension speed can be defined by adjusting the piston assembly corresponding to available stages.

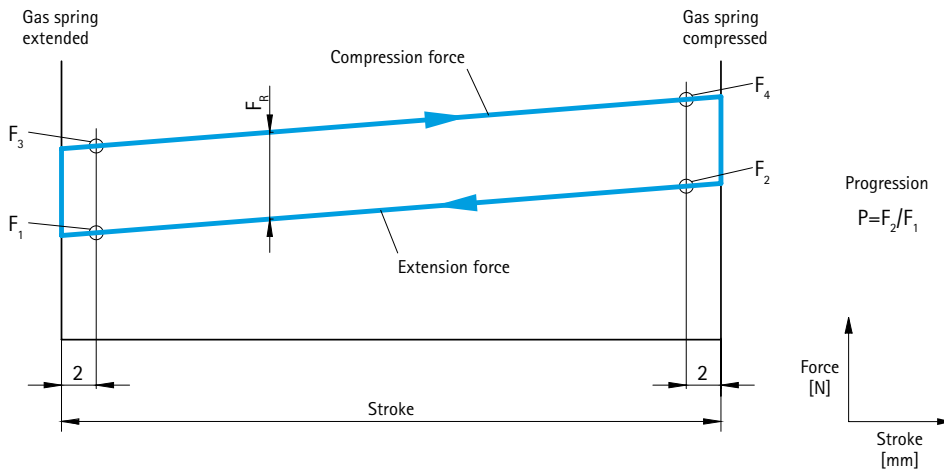

## Dimensions

Gas springs can be classified according to their tube diameter, piston rod diameter, minimum installation length and stroke.

*Further technical data can be found on pages 6 and 7.*

- 1** Tube diameter ..... 22 mm (0.866 in),  
28 mm (0.945 in)
- 2** Diameter of piston rod ..... 10 mm (0.394 in)
- 3** Minimum installation length... depends on stroke
- 4** Stroke ..... 10 mm to 450 mm  
(0.394 in to 17.717 in)

## End fittings

SUSPA supplies a wide variety of connections and end fittings to ensure that the Varilock will be easily integrated into your application. *(Details on page 12)*



## Release systems

The valve in a locking gas spring is actuated via the release pin. To ensure successful compatibility with your application, SUSPA has developed a wide range of release systems. These include levers, cable releases and push-buttons that are all adjusted and customized to each application.

*(Details can be found on pages 10-11)*

# The Varilock basic range: Technical specifications



## Elastic locking

Specification	EL1	EL2
Release pin	on piston rod side 	
Locking	elastic	
In compression direction: max. load [N]/(lbs)	6,500 (1,460)	10,000 (2,245)
In extension direction: max. load [N]/(lbs)	3,500 (785)	7,000 (1,572)
<b>1</b> Tube diameter [mm]/(inch)	22 (0.866)	28 (1.102)
<b>2</b> Piston rod diameter [mm]/(inch)	10 (0.394)	
<b>3</b> Min. installation length excluding eyelet [mm]/(inch)	2 x stroke + 70 (2.756)	
<b>4</b> Stroke C [mm]/(inch)	10 - 339 (0.394-13.346)	10 - 450 (0.394 - 17.717)
<b>5</b> End fittings	<a href="#">page 12</a>	
<b>6</b> Release systems	<a href="#">pages 10-11</a>	
Extension forces $F_1$ [N]/(lbs)	80 - 800 (18-180)	80-1,000 (18-225)
Progression ratio ( $F_2/F_1$ )	< 1.25	< 1.2
Release force [N]/(lbs)	0.25 x $F_1$	
Release travel, short [mm]/(inch)	< 0.5 (< 0.02)	
Release travel, normal [mm]/(inch)	2.5 ≤ x ≤ 3.5 (0.098 ≤ x ≤ 0.138)	
Recommended installation position	piston rod pointing downwards	
Permissible operating temperature	-20 °C to +60 °C (-4 °F to 140 °F)	
Permissible storage temperature	-20 °C to +80 °C (-4 °F to 176 °F)	

Special modules	EL1	EL2
AS - AntiShock	x	x
ES - EasySwitch	x	x
TR - TimeReset	-	-
OR - OverRide	-	-
CH / CL ComfortRelease High / Low	x	x

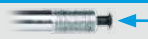

## Rigid locking

Specification	HY1	HY3	HY4	HY6	VOB18-1
Release pin	on piston rod side			on tube side 	
Locking	rigid in tensile direction		rigid in compressive direction		
In compression direction: rigid to [N]/(lbs) / max. load [N]/(lbs)	3.6 x F <sub>1</sub> / 6,500 (3.6 x F <sub>1</sub> / 1,460)	5.8 x F <sub>1</sub> / 10,000 (5.8 x F <sub>1</sub> / 2,245)	10,000 (2,245)	1,200 (270)	3,000 (673)
In extension direction: rigid to [N]/(lbs) / max. load [N]/(lbs)	3,500 (785)	7,000 (1,572)	4.8 x F <sub>1</sub> / 7,000 (4.8 x F <sub>1</sub> / 1,572)	1.6 x F <sub>1</sub>	1.5 x F <sub>1</sub>
<b>1</b> Tube diameter [mm]/(inch)	22 (0.866)		28 (1.102)		
<b>2</b> Piston rod diameter [mm]/(inch)	10 (0.394)				
<b>3</b> Min. installation length excluding eyelet [mm]/(inch)	2.6 x stroke + 76 (2.992)	2.4 x stroke + 76 (2.992)	2.6 x stroke + 85 (3.346)	2 x stroke + 110 (4.331)	2 x stroke + 90 (3.543)
<b>4</b> Stroke C [mm]/(inch)	10-300 (0.394-11.811)	10-450 (0.394-17.717)	10-300 (0.394-11.811)	10-450 (0.394-17.717)	20-300 (0.787-11.811)
<b>5</b> End fittings	<a href="#">Page 12</a>				
<b>6</b> Release mechanism	<a href="#">Pages 10-11</a>				
Extension forces F <sub>1</sub> [N]/(lbs)	80-800 (18-180)	80-1,000 (18-225)		70-400 (16-90)	150-1,000 (34-225)
Progression ratio (F <sub>2</sub> /F <sub>1</sub> )	< 1.6	< 1.5	< 1.6	< 1.6	< 1.7
Release force [N]/(lbs)	0.25 x F <sub>1</sub>				0.4 x F <sub>1</sub>
Release travel, short [mm]/(inch)	< 0.5 (0.020)				-
Release travel, normal [mm]/(inch)	2.5 ≤ x ≤ 3.5 (0.098 ≤ x ≤ 0.138)				
Recommended installation position	any	any	piston rod pointing downwards	any	piston rod pointing downwards
Permissible operating temperature	-20°C to +60°C (-4°F to 140°F)			-10°C to +60°C (14°F to 140°F)	-20°C to +60°C (-4°F to 140°F)
Permissible storage temperature	-20°C to +80°C (-4°F to 176°F)				

Special modules	HY1	HY3	HY4	HY6	VOB18-1
AS - AntiShock	x	x	x	-	-
ES - EasySwitch	x	x	x	-	-
TR - TimeReset	-	x	x	-	-
OR - OverRide	-	-	-	x	-
CH / CL ComfortRelease High / Low	x	x	x	x	-

# Special functions

## AntiShock AS: comfort and safety combined

The "AntiShock" module detects the load situation of the application and acts accordingly. When used in an office chair with dynamic free-swinging, the Varilock with AntiShock provides the user with smooth moving action (comfort function). In addition, it will return the non-loaded backrest slowly from the reclined to the vertical position when released. Thus it will avoid the so-called catapult effect (safety function).

In the case of height-adjustable tables which have a low intrinsic weight but are subjected to high loads when in use (Varilock with a high extension force), the Varilock allows a quick height adjustment of the loaded table and, thanks to AntiShock, also prevents the tabletop rising up too quickly when the empty, unloaded table is released.



## EasySwitch ES: locking that can be switched on and of

With the "EasySwitch" module, the user controls the valve "digitally", alternating between the closed and permanently open position and back again. You switch between the two modes by activating the pin through the release mechanism.

With EasySwitch, the valve stays either open (swinging function) or closed (locked backrest) as per the user's settings.

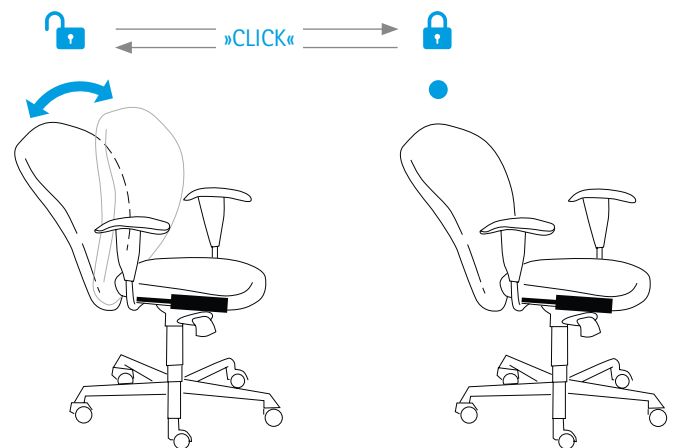

## OverRide OR: smooth extension without actuation

The "OverRide" module allows a person to move the application in the extension direction without having to activate the release function. In the case of desk or table applications, a gentle upwards force applied to the tabletop adjusts the height of the table. Once the desired position has been achieved, locking in the compression direction is rigid.

OverRide provides smooth, comfortable operation and was first designed for use in hospital beds and over-bed tables. It also allows for single-hand operation of the application.

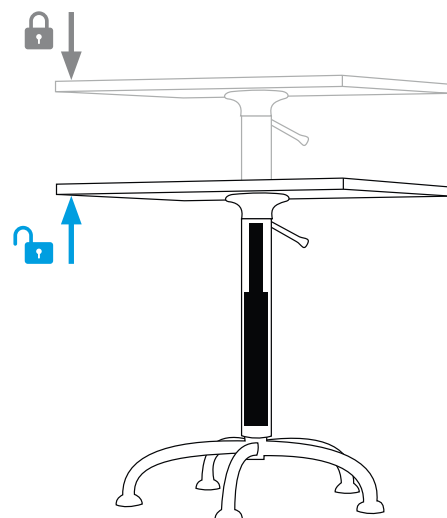



## TimeReset TR: automatic return

The "TimeReset" automatically detects whether the application is charged with a person's weight or not. When loaded, the Varilock operates in the usual manner and permits locking at any position. When the application is not loaded, the Varilock returns it to the starting position (vertical backrest) within a custom defined time period. This auto-return feature is particularly well-suited for passenger seats or conference chairs.

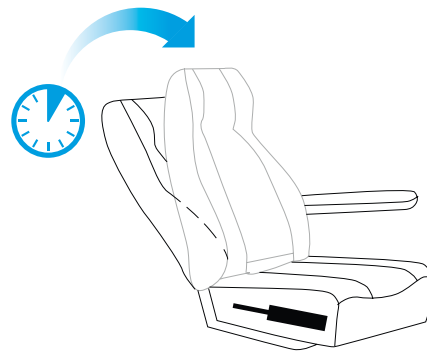

## ComfortRelease CH / CL: optimal user comfort combined with maximum reliability

By using "Comfort Release", the Varilock is adaptable to the specific requirements of any application in order to provide the greatest user comfort combined with maximum reliability.

A user-friendly release system generally means that the actuation force required to use the control element (e.g. bowden cable, button, lever) is as low as possible. At the same time, functional reliability demands a sufficiently high resetting force to be present. Conventional valve arrangements (Standard Release) can only successfully fulfill these two competing demands when moderate extension forces are present. SUSPA will provide advice and support regarding the optimization of your application (see the following examples).

### Example 1: Comfort Release Low CL

The gas spring has a large extension force  $A_H$  and Standard Release (black graph) to meet the demand of the application. This results in an actuation force  $B_H$  that is too high for the user. This operating point is above the comfort zone (the blue region). Comfort Release Low provides optimal user comfort by combining a reduced actuation force ( $B_C$  = orange graph) at the same extension force.

### Example 2: Comfort Release High CH

The gas spring has a low extension force  $A_L$  and Standard Release (black graph) to meet the demand of the application. This results in a resetting force  $R_N$  that provides insufficient reliability and is below the secure zone (blue region). Comfort Release High delivers maximum reliability thanks to an increased resetting force ( $R_C$  = green graph) at the same extension force.

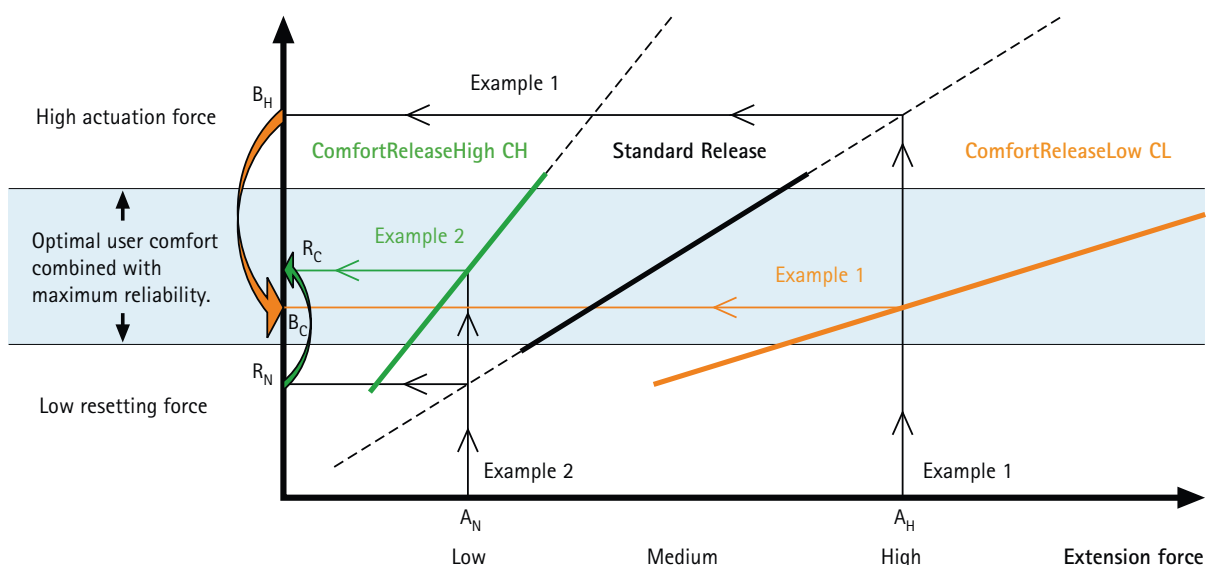

# Release systems

Optimize your application: Configure your individual release system choosing a release lever, release mechanism and the length of the bowden cable.

## Release head with bowden cable

### SusflexRegular

axial release: cable mounted parallel to gas spring

Force ratio	Eyelet 8 mm (0.315 in)	Eyelet 10 mm (0.394 in)
1:2	06550018 + 06550020	06550019 + 06550020

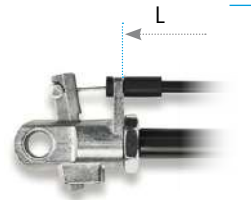

### SusflexSide

90° release: cable mounted perpendicular to gas spring

Force ratio	Eyelet 8 mm (0.315 in)	Eyelet 10 mm (0.394 in)
1:2	02152022	02152021

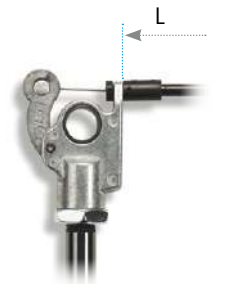

### SusflexMulti

axial release with higher force ratio

Force ratio	Eyelet 8 mm (0.315 in)	Eyelet 10 mm (0.394 in)	Comments
1:6	02152005	02152008	
1:10	02152006	02152009	
1:20	02152007	02152010	
1:6	02152015	02152018	with resetting spring*
1:10	02152016	02152019	with resetting spring*
1:20	02152017	02152020	with resetting spring*

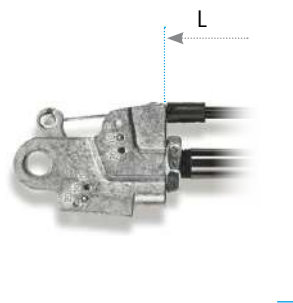

\* Recommended for low actuation forces in order to help achieve complete resetting of the actuation element.

## Release head with lever

### SusflexDirect

for lever release

Type	Eyelet 8 mm (0.315 in)	Eyelet 10 mm (0.394 in)	Comments
1	02100075	02150102	standard lever
2	02150103	02160004	lever can be locked
3	06552018	06552017	for table application



Type 1 + 2



Type 3

## Bowden cables

SUSPA supplies a wide variety of bowden cables in various lengths and designs. They can be operated by means of buttons and/or levers.

**i** The following parameters and properties can be adjusted/selected: length, color, fittings, diameter, low friction casing, cables and adjustment elements.



Example for bowden cables



Example for bowden cables

## Release levers

### Levers



### Buttons with various finishes



## Metal levers for SusflexDirect

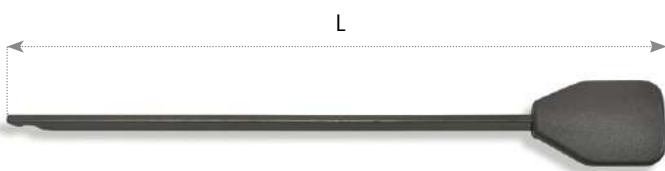

Length L [mm] / (inch)	Ordering number
365 (14.0)	16952000
145 (5.7)	16952001
250 (9.8)	16952003
305 (12.0)	16952004
80 (3.2)	16952008

# End fittings

## Steel joint eyelets

to meet the highest demands on stability and durability

Part number	a	l1	l2	d1	d2
06752017	10 (0.394)	19.5 (0.768)	13 (0.512)	8 (0.315)	M8
06700338	10 (0.394)	20.5 (0.807)	14 (0.551)	8 (0.315)	M8
06700344	10 (0.394)	22.5 (0.886)	16 (0.630)	8 (0.315)	M8
06750019	10 (0.394)	23.5 (0.925)	14 (0.551)	10 (0.394)	M8
06700343	12 (0.472)	21.5 (0.846)	14 (0.551)	10 (0.394)	M8
06700336	12 (0.472)	23.5 (0.925)	16 (0.630)	10 (0.394)	M8

All figures in [mm]/(inch)

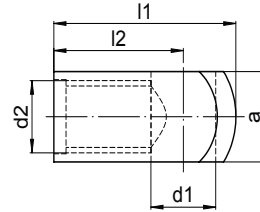

## Zinc joint eyelets

for applications subject to low loads

Part number	a	l1	l2	d1	d2
06500155	12 (0.472)	25.5 (1.004)	16 (0.630)	8 (0.315)	M8
06500145	12 (0.472)	25.5 (1.004)	16 (0.630)	10 (0.394)	M8
06500029	12 (0.472)	25.5 (1.004)	16 (0.630)	12 (0.472)	M8

All figures in [mm]/(inch)

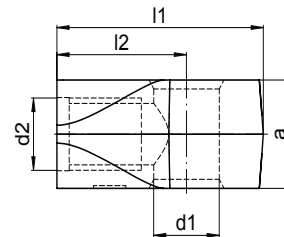

## Zinc joint eyelets with a plastic bushing

for smooth function and installation that is free of clearance

Part number	a	l1	l2	d1	d2
16560002	12 (0.472)	25.5 (1.004)	16 (0.630)	8 (0.315)	M8
16560003	12 (0.472)	25.5 (1.004)	16 (0.630)	10 (0.394)	M8

All figures in [mm]/(inch)

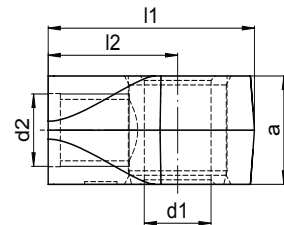

## Steel joint eyelets

for particularly thin fork receptors

Part number	a	l1	l2	d1	d2	d3	g
06750017	5 (0.197)	38 (1.496)	28 (1.102)	10 (0.394)	M8	16 (0.630)	10.5 (0.413)
06700348	5 (0.197)	36 (1.420)	28 (1.102)	8 (0.315)	M8	16 (0.630)	10.5 (0.413)

All figures in [mm]/(inch)

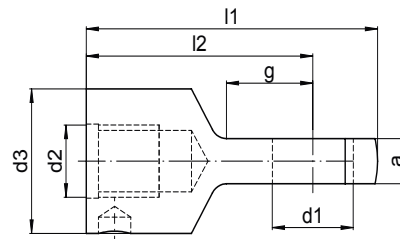

## Steel fork heads

for ease of assembly and to meet the highest demands on stability and durability

Part number	a	b	l1	l2	d1	d2	g
06800124	16 (0.630)	8 (0.315)	42 (1.645)	32 (1.260)	8 (0.315)	M8	16 (0.630)
06800132	20 (0.787)	10 (0.394)	52 (2.047)	40 (1.575)	10 (0.394)	M8	20 (0.787)

All figures in [mm]/(inch)

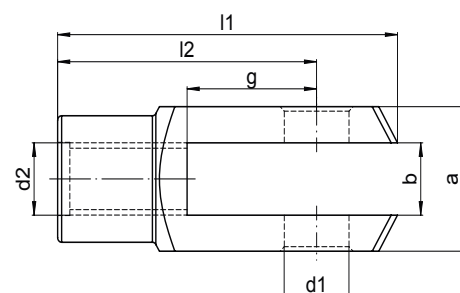

# SUSPA expertise in systems solutions: components

## Customer-specific, ready-to-install components

Using preset Varilock components will help reduce your production and purchasing costs and will also improve your product quality.

We supply gas springs with, for example, a precisely set release pin distance and installation length with tight tolerances and customer-specific end fittings. We do this so you do not have to adjust our product during your production process.

By purchasing complete components, you can reduce your number of suppliers and simplify your production process. SUSPA will ensure that

Varilock matches up perfectly to your application thanks to additional parts such as dust-protection caps and prefitted components – all from a single supplier. You too can profit from our vast experience.

Satisfied customers from many industrial sectors can already vouch for the benefits of working with us.

## For a precise release mechanism and long service life



## For ease of assembly and mechanism with no clearance



## For precise function of the release system and assembly without adjusting work

Bowden cable incl. actuating unit preinstalled by SUSPA and preset to the exact installation position for your application.



# SUSPA expertise in system solutions: VariStand

## The design-orientated table column

The VariStand table column is a professional, sophisticated, design-orientated solution for all table and cart applications. It is characterized by its ease of use and plug & play assembly. VariStand offers high-quality and comfortable height adjustment.



## Highlights

- Elegant design with round tubes
- Precise, quiet guide system
- Rigid or elastic locking in any position
- Constant force, independent of position
- Non-rotational column
- Large adjustment range despite short installation length
- Quick and easy to adjust
- Plug & Play assembly
- OverRide-function: tabletop can be lifted without activating the release (optional)

## Applications

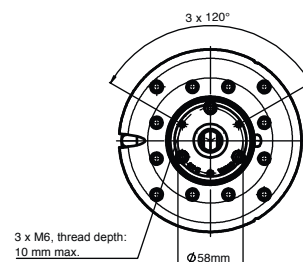
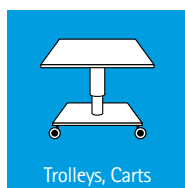
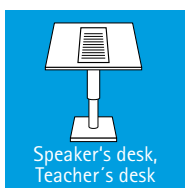

Features	Values
Diameter [mm]/(inch)	Ø 75 / Ø 70 (2.95 / 2.76)
Stroke [mm]/(inch)	max. 450 (17.7) (standards 415 / 225)
Length compressed ( $L_{\text{compr.}}$ ) [mm]/(inch)	stroke + 166 (6.5)
Length extended ( $L_{\text{extended}}$ ) [mm]/(inch)	$L_{\text{compr.}}$ + stroke, max. 1,065 (42.0)
Stroke force	from 70 N (16 lbs) up to 400 N (90 lbs), according to weight of tabletop or application
Surface finishing	chrome plated, powder-coated (RAL colors)
Activation / release	lever, cable release
Tabletop fitting	flange adapter (with 12 drillholes, distance 32 mm, 1.26 in)
Base fitting	flange or tapered cone adapter
Non-rotation function	standard
OverRide function	optional

Features	Ordering number			
	13652065	13652067	13652064	13652066
Diameter [mm]/(inch)	75 / 70 (2.95 / 2.85)			
Stroke [mm]/(inch)	415 (16.3)	225 (8.9)	415 (16.3)	225 (2.95 / 2.85)
Length compressed ( $L_{\text{compr.}}$ ) [mm]/(inch)	625 (24.6)	435 (17.1)	625 (24.6)	435 (17.1)
Length extended ( $L_{\text{extended}}$ ) [mm]/(inch)	1,040 (40.9)	660 (26.0)	1,040 (40.9)	660 (26.0)
Stroke force [N]/(lbs)	120 (27.0)			
Surface finishing	chrome	chrome	silver grey	silver grey
Activation / release	Bowden wire release system L = 280 mm (11.0 in)			
Tabletop fitting	flange			
Base fitting	flange with hole-pattern 3 x M6, Ø 58 mm (2.3 in)			
Non-rotation function	standard			
OverRide function	none			

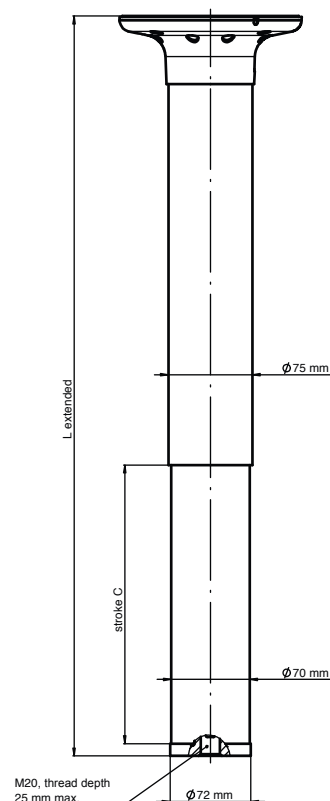

# SUSPA expertise in system solutions: VariBase

## The robust table column

The pneumatic height adjustable system VariBase is a professional and extremely robust holistic solution for table applications. It is particularly characterized by ease of handling and Plug & Play installation. VariBase stands out for its application with a long service life and offers comfortable height adjustment.



## Highlights

- Elegant design with square tubes
- Available in versions BTU - Big Tube Up and BTD - Big Tube Down
- Robust guide system
- Available in two versions of gas springs (rigid and elastic locking)
- Non-rotational column
- Quick and easy to adjust
- Plug & Play assembly

## Applications

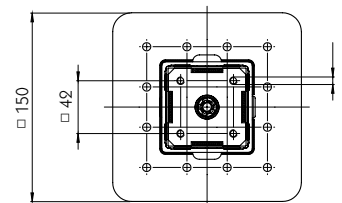
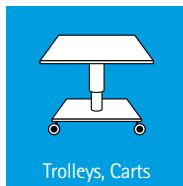
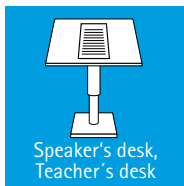

Features	Values		
Dimension BTU (Big Tube Up) [mm]/(inch)	□ 70 (2.76) / □ 65 (2.56)		
Dimension BTD (Big Tube Down) [mm]/(inch)	□ 60 (2.36) / □ 65 (2.56)		
Stroke [mm]/(inch)	400 (15.75)	290 (11.42)	215 (8.46)
Length compressed ( $L_{\text{comp.}}$ ) [mm]/(inch)	640 (25.2)	525 (20.67)	440 (17.32)
Length extended ( $L_{\text{extended}}$ ) [mm]/(inch)	1,040 (40.9)	815 (32.1)	655 (25.79)
Stroke force	120N (27lbs), recommended weight of table top: ~ 6kg (13lbs) further $F_1$ -force on request (70 - 400 N / 16 - 90 lbs)		
Surface finishing	powder coated (RAL9006), further RAL-colors on request		
Activation / release	lever, cable release		
Tabletop fitting	flange adapter with 12 drillholes, distance 32 mm (1.26 in)		
Base fitting	flange with 4 x M6		
Non-rotation function	standard		

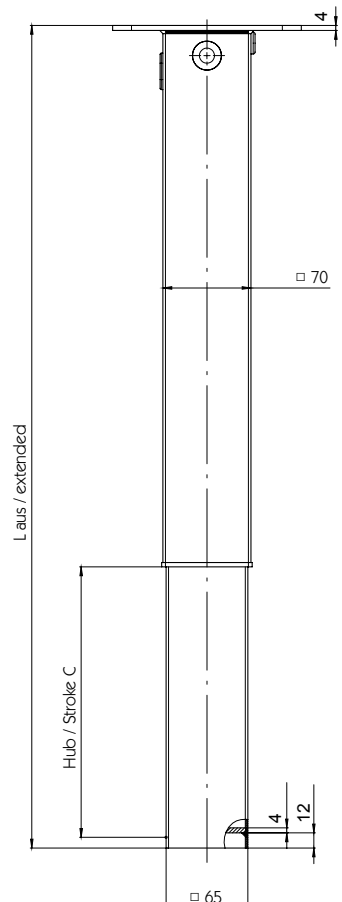



# Areas of application of lockable gas springs

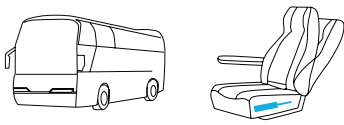

## Public transportation

### Busses and coaches

- Backrest
- Leg support

### Trains

- Seat tilting
- Table height

### Airplanes

- Backrest
- Leg support
- Table height

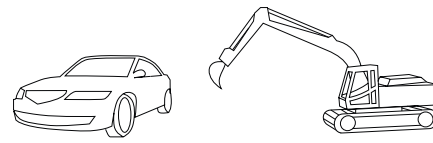

## Automobile

- Steering column angle and length
- Covers for trunk lids and tonneau covers
- Multi-functional armrest for driver's seat
- Equipment for mobile homes and recreational vehicles (backrest system, screen support, table, ...)

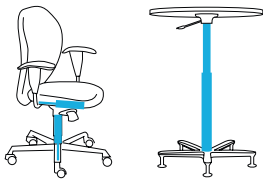

## Furniture

### Home furniture

- Positioning of chairs and of individual sections of beds
- Head support, backrest and leg support for armchairs
- Height adjustment for bedside tables/over-bed tables
- Complete, ready-to-install column for height adjustment of tables

### Office furniture

- Height of keyboard support
- Desk height
- Angle of backrest and seat surface for office chairs
- Sit-to-stand work surfaces and podiums

### School furniture

- Tabletop tilting
- Seat tilting
- Height of chairs and podiums for teachers and students

### Chairs

- Chair tilting
- Footrest height

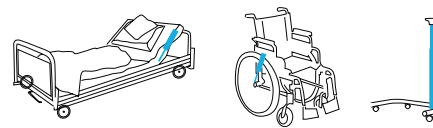

## Medical and rehab applications

### Wheelchairs and caddies

- Backrest, angle and height of seat, as well as leg support

### Therapy beds and chairs

- Adjusting the height and tilting of various elements

### Hospital beds and tables

- Adjusting the height and tilting of various bed parts
- Bed length
- Height adjustment for bedside tables, servers and keyboard supports
- Complete, ready-to-install column for table-height adjustment

### Medi-Carts

- Guide systems and complete columns for vertical adjustment
- Tilt adjustment
- Complete mechanical system with base, column and tabletop





# Client references

## The seats in the ICE high speed train are adjusted using Varilock

SUSPA is the perfect partner when it comes to integrating comfort features into both passenger and driver seats. Major customers in the transportation market profit from SUSPA's expertise and from special features such as the innovative TimeReset function ([see page 9 for details](#)).



**ICE**

## Actiu, manufacturer of office furniture, relies on SUSPA's gas springs for its high-end chairs

The lockable gas spring to adjust the backrest is equipped with the EasySwitch and AntiShock special functions ([details see pages 8](#)). Both of these special functions are combined in one Varilock gas spring. Thus, the office chair offers the optimum comfort in seating and adjustment.



# SUSPA – Your development partner

## Benefit from our expertise.

As your solution partner for complex technical problems, we will work in cooperation with you to develop concepts and products that are tailor-made to meet your individual needs. We will call upon our comprehensive range of SUSPA products as well as offering customized solutions to find the most effective and feasible solution for your application.

We support you through all stages of your project: starting with your initial inquiry, continuing through the development phase, right up to series production and beyond! Partnership and cooperation result in systems that perfectly meet your specific requirements. You will

benefit from our culture of innovation and quality, our technical expertise and our extensive production capabilities. We are a world leader in gas springs and systems solutions for a variety of markets – depend on us.

SUSPA's technical knowledge is the result of decades of experience and partnership with our customers and their applications, over wide range of markets and sectors. By working in close cooperation with us from product development right through to production, you too could profit from this comprehensive knowledge and reap the rewards of reduced costs and improved quality and functionality!

## SUSPA can support your process at every project phase

### 1 Development

- + Innovation
- + Prototype optimization
- + Samples available at an early stage
- + Cost-optimized production planning

= **Shorter development times**

### 2 Purchasing

- + Shorter lead times (flexible capacity planning, production locations worldwide)
- + Fast response when forecast changes
- + Flexible supply concepts (call-off purchase agreements, frame work agreements, security storage)
- + Supply of ready-to-install, premounted components from a single supplier (perfect integration with other parts and components)

= **Optimized purchasing concept**

### 3 Production

- + Advice and consulting relating to development of production concept
- + Simplify your production thanks to perfectly fitting components
- + Reduced assembly and testing costs

= **Reduced production costs**

### 4 Sales & marketing

- + Innovative special functions
- + Highest product quality possible
- + Excellent planning reliability (e.g. for promotional activities or trade fairs)

= **Competitive advantage thanks to more attractive products**

### 5 In marketplace

- + Market-oriented series production
- + Avoid customer complaints and callbacks
- + Longer service life
- + Functional reliability

= **Improved customer satisfaction**

## The benefits for your product

- Lower overall costs
- Improved quality
- Lower time to marketplace
- Greater planning reliability (costs and time)
- Successful series production
- Improved market position



## Technical advice

### Storage

After longer periods of storage, a slight oil film may materialize at the piston rod side of the product. Such materialization is system-specific and has no impact on the function. Storage of the parts should be piston rod downward. Please activate the parts at least once after six months of storage.

### Handling

SUSPA products may stand under high pressure. In order to avoid reduction of service life, safety and function, piston rods are not to be damaged, painted, or treated with aggressive materials. Keep away from foil and paper packaging (statical charging). Radial stress effects, impact effects, any type of alteration or manipulation (f. e. opening), tensile load, heating, re-painting, removal of imprints, bulk handling, as well as extreme influence of wastewater, splash or salt water are not permissible. The outer tube is not to be deformed or damaged. Products that were modified or damaged in any kind must not be put into operation and have to be exchanged.

### Utilization

Your specific application is the basis for the technical design of SUSPA products. Please discuss your particular requirements with our application technicians in advance. Our products fulfill the specifications shown in SUSPA drawings. Unless otherwise specified, the products are to be used with the piston rods pointing down within a temperature range of  $-25^{\circ}\text{C}$  up to  $+60^{\circ}\text{C}$  ( $-13^{\circ}\text{F}$  up to  $140^{\circ}\text{F}$ ), in exceptional cases also within  $-30^{\circ}\text{C}$  up to  $+80^{\circ}\text{C}$  ( $-22^{\circ}\text{F}$  up to  $176^{\circ}\text{F}$ ). A detailed description of any specific gas spring can be found on its data sheet/drawing.



SUSPA GmbH  
Industriestr. 12-14  
90518 Altdorf  
Germany

Telephone +49 9187 930 355  
Fax +49 9187 930 311

E-mail [infoindustry@de.suspa.com](mailto:infoindustry@de.suspa.com)  
Internet [www.suspa.com](http://www.suspa.com)

[www.suspa.com](http://www.suspa.com)