

Southco® Captive Fasteners

Polished, Spring-ejected Series, M3 Thread

- Highly polished appearance

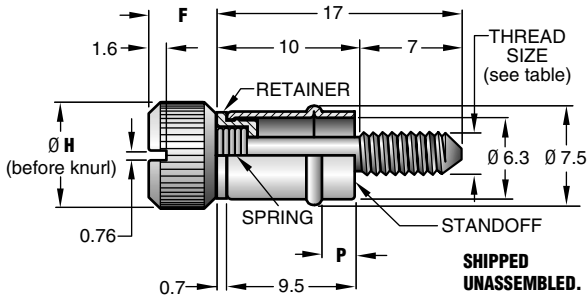

Caution: Do not exceed 0.4 N•m tightening torque when fastening.

Material and Finish

SCREW: 302 Stainless steel.

STANDOFF: 305 Stainless steel.

BOTH PARTS are passivated or are passivated plus black organic coating.

SPRING: 302 Stainless steel.

RETAINER: Natural color nylon.

Note: Each part number represents a screw and standoff **shipped unassembled**, protectively packaged (bright standoffs are bulk packaged).

YOUR OUTER PANEL THICKNESS		DIMENSIONS			THREAD SIZE	PART NUMBERS
MIN.	MAX.	P	Ø H	F		
BLACK screw assemblies						
1.3	1.7	1.6	7.1	4.0	M3 x 0.5	53-72-410-26
2.1	2.5	2.3				53-72-510-26
2.9	3.3	3.2				53-72-610-26
BRIGHT POLISHED screw assemblies						
1.3	1.7	1.6	7.1	4.0	M3 x 0.5	53-72-410-24 •
2.1	2.5	2.3				53-72-510-24 •
2.9	3.3	3.2				53-72-610-24 •

To Install Standoff

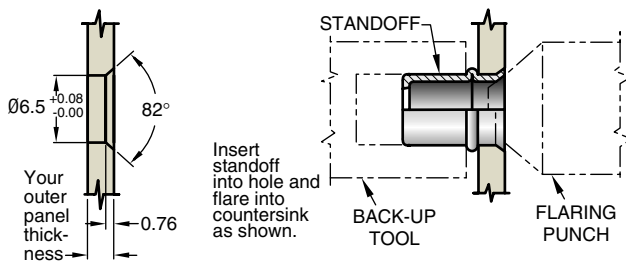

Standoff Installation Tools

(Order separately).



PART NUMBER
54-0-5467-11

Material
Hardened steel.

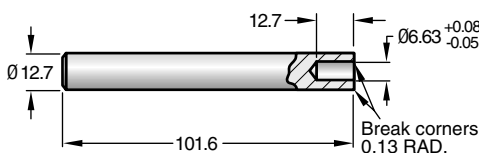

PART NUMBER
54-0-5466-11

Material
Hardened steel.

To Captivate Screw

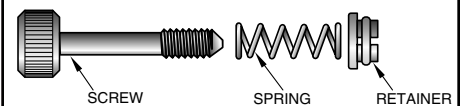

Assemble seating end of spring into recess retainer.

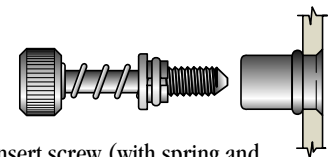

Insert screw (with spring and retainer) into standoff.

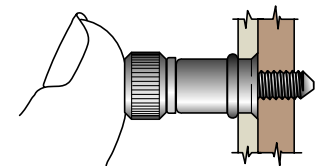

Press to snap retainer into standoff.

millimeter (inch)
millimeter
(inch)

Dimensions without tolerances are for reference only.

Southco® Captive Fasteners

**Polished, Spring-ejected Series,
4-40 and 6-32 Thread**

• **Highly polished appearance**

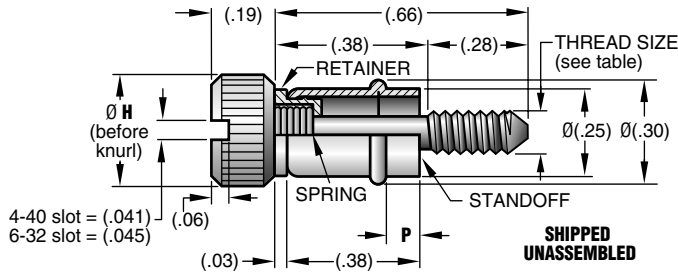

Caution: Do not exceed 3-1/2 in.-lb. tightening torque when fastening

BLACK screw assemblies

OUTER PANEL THICKNESS			PART NUMBERS		P
			4-40	6-32	
MIN.	NOM.	MAX.	Ø H = (.31)	Ø H = (.31)	
(.05)	(.06)	(.07)	53-10-406-26	53-18-406-26	(.06)
(.08)	(.09)	(.10)	53-10-506-26	53-18-506-26	(.09)
(.11)	(.12)	(.13)	53-10-606-26	53-18-606-26	(.13)

BRIGHT POLISHED screw assemblies

your OUTER PANEL THICKNESS			PART NUMBERS		P
			4-40	6-32	
MIN.	NOM.	MAX.	Ø H = (.31)	Ø H = (.31)	
(.05)	(.06)	(.07)	53-10-406-24 •	53-18-406-24 •	(.06)
(.08)	(.09)	(.10)	53-10-506-24 •	53-18-506-24 •	(.09)
(.11)	(.12)	(.13)	53-10-606-24 •	53-18-606-24 •	(.13)

Material and Finish

NO. 4 SCREW: 303 Stainless steel. NO. 6 SCREW: 302 Stainless steel. STAND-OFF: 305 Stainless steel. SCREWS and STANDOFFS are passivated or are passivated plus black organic coating. SPRING: 302 Stainless steel, passivated. RETAINER: NO. 4 size, natural color nylon; No. 6 size, black nylon.

Fasteners are ordered by their assembly part number but are shipped and identified as components of the finished assembly.

To Install Standoff

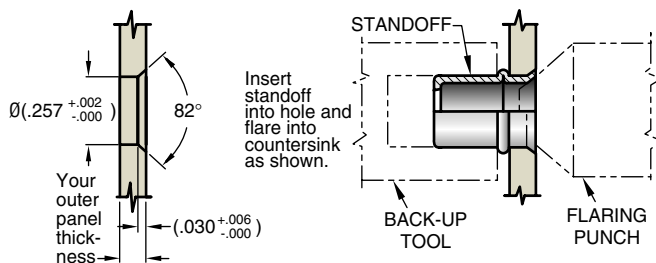

Standoff Installation Tools

(Order separately).

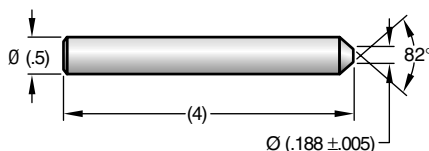

PART NUMBER
54-0-5467-11

Material
Hardened steel.

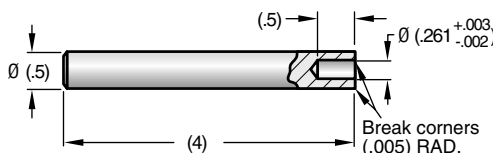

PART NUMBER
54-0-5466-11

Material
Hardened steel.

To Captivate Screw

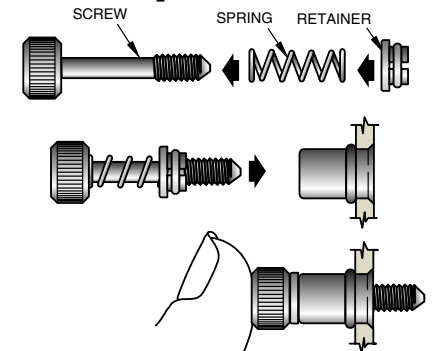

1. Assemble, seating end of spring into recess in retainer.
2. Insert screw (with spring and retainer) into standoff.
3. Press to snap retainer into standoff.

millimeter (inch)
millimeter (inch)

Dimensions without tolerances are for reference only.

Captive Fasteners
Captive Screws

Southco® Captive Fasteners

**Polished, Spring-ejected Series,
M4, M5 and M6 Thread**

• **Highly polished appearance**

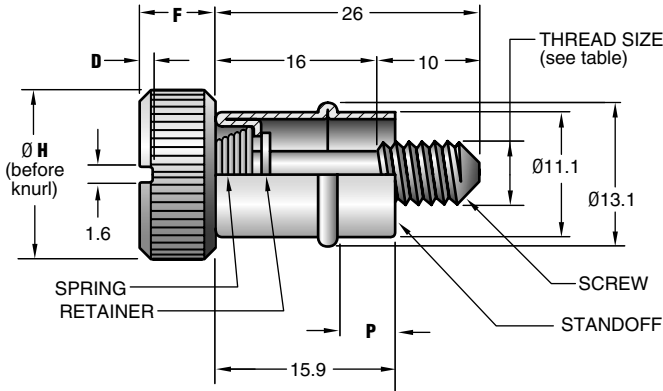

DIMENSIONS				THREAD SIZE	PART NUMBERS
P	ØH	D	F		

BLACK screw assemblies

3.2	10.3	1.6	6.0	M4 X 0.7	53-74-716-26
4.8					53-74-816-26
6.3					53-74-916-26
3.2	11.1	1.6	6.3	M5 X 0.8	53-76-716-26
4.8					53-76-816-26
6.3					53-76-916-26
3.2	14.3	2.3	6.3	M6 X 1.0	53-77-416-26
4.8					53-77-516-26
6.3					53-77-616-26

BRIGHT POLISHED screw assemblies

3.2	10.3	1.6	6.0	M4 X 0.7	53-74-716-24 •
4.8					53-74-816-24 •
6.3					53-74-916-24 •
3.2	11.1	1.6	6.3	M5 X 0.8	53-76-716-24 •
4.8					53-76-816-24 •
6.3					53-76-916-24 •
3.2	14.3	2.3	6.3	M6 X 1.0	53-77-416-24 •
4.8					53-77-516-24 •
6.3					53-77-616-24 •

Note: Longer screw lengths and unslotted head styles are available on special order.

To Install Standoff

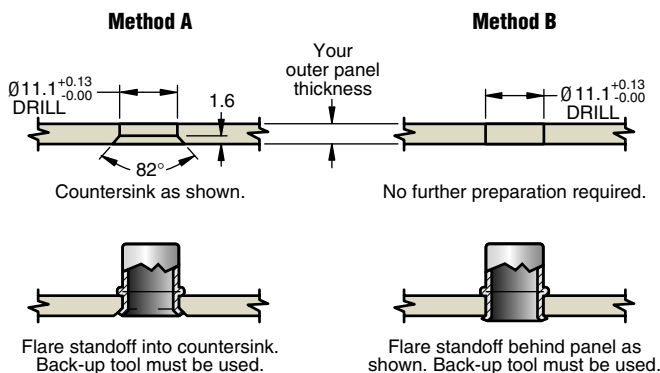

To select proper screw assembly

1. Measure your outer panel thickness and enter SCREW ASSEMBLY SELECTION TABLE (right) with your thickness.
2. Read across to find **P** dimension and installation method (A or B).
3. Enter ASSEMBLY PART NUMBER TABLE (right) with your **P** dimension, at section having your desired thread size, and read across to find correct assembly part number.

Screw Assembly Selection Table

Your Outer Panel Thickness		Select an assembly with P dim. of:	Use this installation method
MIN.	MAX.		
1.6	1.9	3.2	B
2.3	3.6	4.8	B
2.8	3.6	3.2	A
3.9	5.2	6.3	B
4.4	5.2	4.8	A
5.9	6.7	6.3	A

Material and Finish

SCREW: 302 Stainless steel. STAND-OFF: 305 Stainless steel. SCREWS and STANDOFFS: Passivated or are passivated plus black organic coating. SPRING and RETAINER: 302 Stainless steel, passivated.

Each part number represents a screw and standoff shipped unassembled, protectively packaged (bright standoffs are bulk packaged).

millimeter (inch)
millimeter
(inch)

Dimensions without tolerances are for reference only.

Captive Fasteners
Captive Screws

Southco® Captive Fasteners

Polished, Spring-ejected Series, M4, M5 and M6 Thread

Installation

To Captivate Screw

1. Slip spring over shank of screw. Spring must be oriented as shown in diagram.
2. Insert screw (with spring) through hole in standoff.

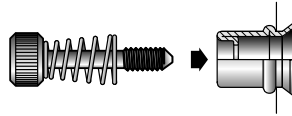
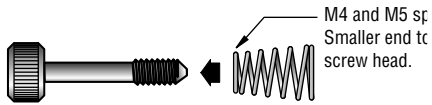

3. Insert retainer into recess in end of tool.
4. Hold screw head and rotate tool until retainer is threaded onto throat of screw.

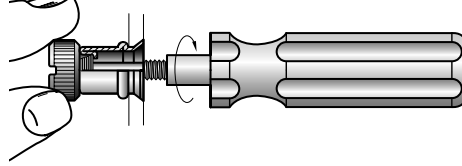
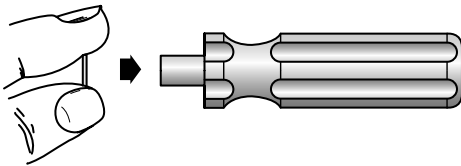

Split Ring Retainer

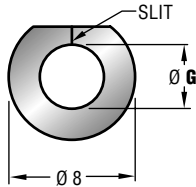

SCREW THREAD SIZE	Ø G
M4 x 0.7	3.5
M5 x 0.8	4.2
M6 x 1	5.1

Installation Tools (Order separately).

for larger metric spring-ejected NO. 53 assemblies

For Retainers

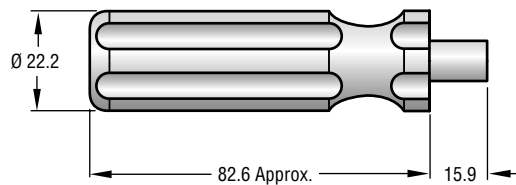

PART NUMBER
29-53-101-10•

For Standoff

Flaring Punch

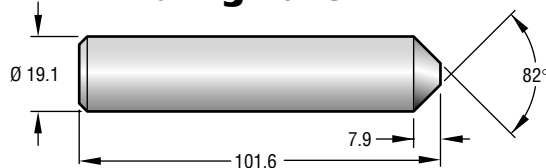

PART NUMBER
90-2824-11•

Material
Hardened steel.

Back-up Tool

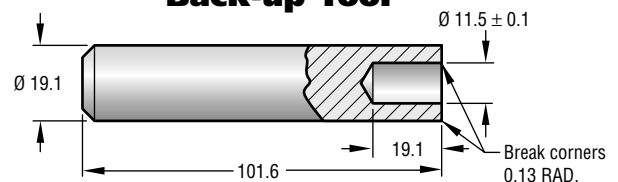

PART NUMBER
90-2825-11•

Material
Mild steel.

millimeter (inch)
millimeter
(inch)

Dimensions without tolerances are for reference only.

Southco® Captive Fasteners

Polished, Spring-ejected Series,
8-32, 10-32 and 1/4-20 Thread

• Highly polished appearance

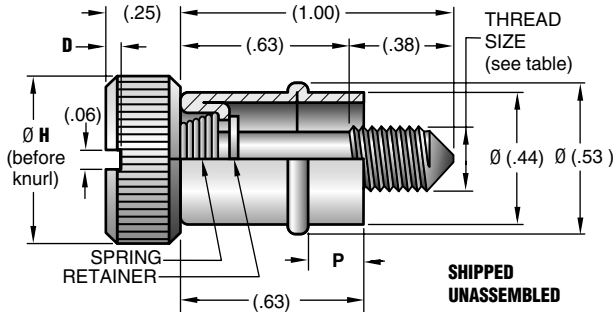

Ø H	D
(.69)	(.13)
(.56)	(.09)
(.44)	(.06)

To Select Proper Screw Assembly

1. Measure your outer panel thickness and enter table (below) with your thickness.
2. Read across to find **P** dimension and installation method (A or B).
3. Enter part number table with your **P** dimension and read across to find correct assembly part number under head and thread size desired.

Slotted BLACK screw assemblies

P	Ø H = (.44)		Ø H = (.56)	Ø H = (.69)
	8-32	10-32	1/4-20	1/4-20

Screws will fully retract

(.13)	53-17-710-26	53-16-710-26	53-11-410-26	53-11-110-26
(.19)	53-17-810-26	53-16-810-26	53-11-510-26	53-11-210-26
(.25)	53-17-910-26	53-16-910-26	53-11-610-26	53-11-310-26

Slotted BRIGHT POLISHED screw assemblies

P	Ø H = (.44)		Ø H = (.56)	Ø H = (.69)
	8-32	10-32	1/4-20	1/4-20

Screws will fully retract

(.13)	53-17-710-24 •	53-16-710-24 •	53-11-410-24 •	53-11-110-24 •
(.19)	53-17-810-24 •	53-16-810-24 •	53-11-510-24 •	53-11-210-24 •
(.25)	53-17-910-24 •	53-16-910-24 •	53-11-610-24 •	53-11-310-24 •

your Outer Panel Thickness		Select an assembly with P dim. of:	Use this installation method
MIN.	MAX.		
(.06)	(.08)	(.13)	B
(.09)	(.14)	(.19)	B
(.11)	(.14)	(.13)	A
(.16)	(.20)	(.25)	B
(.17)	(.20)	(.19)	A
(.23)	(.27)	(.25)	A

Captive Screws

Installation

To Install Standoff

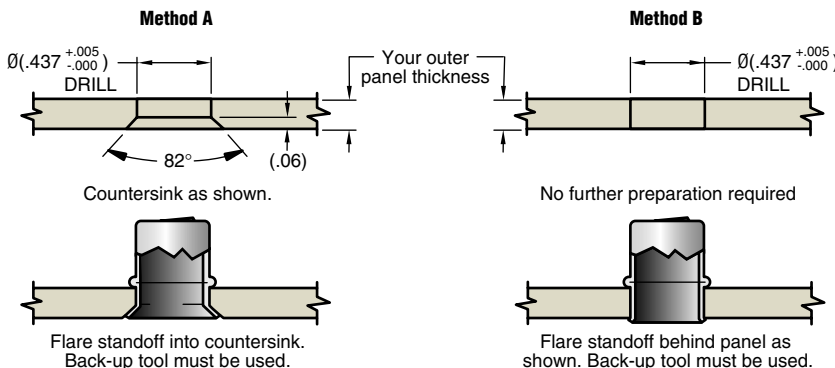

Material and Finish

SCREW, SPRING, and RETAINER: 302 Stainless steel, passivated.
STANDOFF: 305 Stainless steel, passivated plus black organic coating.
SPRING and RETAINER: 302 Stainless steel, passivated.

Note: Fasteners are ordered by their assembly part number but are shipped and identified as components of the finished assembly.

millimeter (inch)
millimeter
(inch)

Dimensions without tolerances are for reference only.

Southco® Captive Fasteners

**Polished, Spring-ejected Series,
8-32, 10-32 and 1/4-20 Thread**

Installation

To Captivate Screw

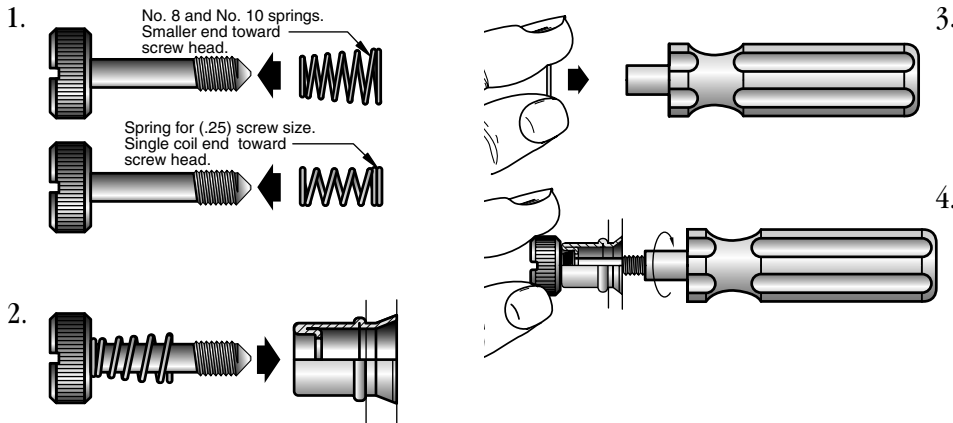

To Captivate Screw

1. Slip spring over shank of screw. Spring must be oriented as shown in diagram.
2. Insert screw (with spring in place) through hole in standoff.
3. Insert retainer into recess in end of tool.
4. Hold screw head and rotate tool until retainer is threaded onto throat of screw.

Split Ring Retainer

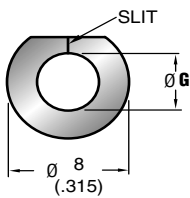

SCREW THREAD SIZE	D
No. 8	(.139)
No. 10-32	(.165)
1/4-20	(.202)
No. 10-24	(.149)

Installation Tool for Retainers

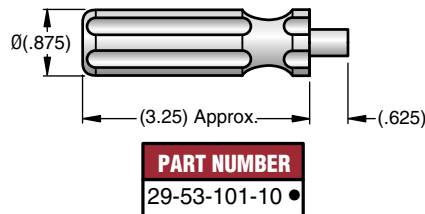

Standoff Installation Tools

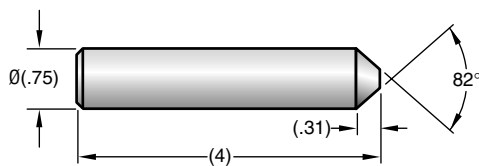

FLARING PUNCH

PART NUMBER
90-2824-11 •

Material
Steel, hardened.

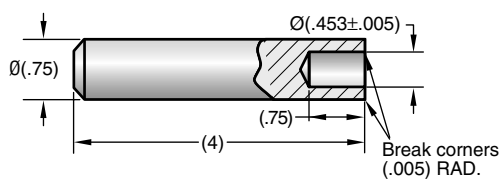

BACK-UP TOOL

PART NUMBER
90-2825-11 •

Material
Steel, hardened.

millimeter (inch)
millimeter
(inch)

Dimensions without tolerances are for reference only.

Southco® Captive Fasteners

Polished Series, M3 Thread

- Simple design
- Highly polished appearance

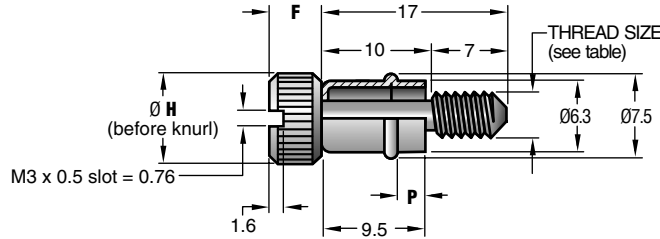

To select proper screw measure your outer panel
Enter table with your thick

YOUR OUTER PANEL THICKNESS		DIMENSION			THREAD SIZE	PART NUMBERS
MIN.	MAX.	Ø H	F	P		

BLACK screw assemblies



1.3	1.7	7.1	4.0	1.6	M3 x 0.5	51-72-410-26
2.1	2.5			2.3		51-72-510-26
2.9	3.3			3.2		51-72-610-26

BRIGHT POLISHED screw assemblies



1.3	1.7	7.1	4.0	1.6	M3 x 0.5	51-72-410-24 •
2.1	2.5			2.3		51-72-510-24 •
2.9	3.3			3.2		51-72-610-24 •

To Install Standoff

1. Insert stand off into hole and flare into countersink as shown.

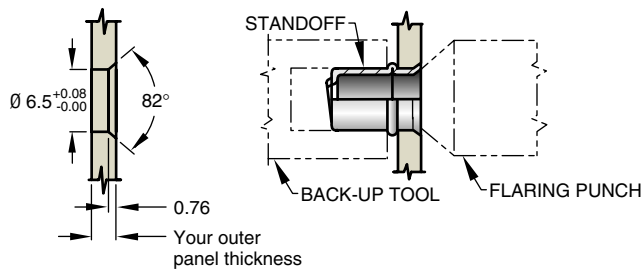

Standoff Installation Tools (order separately).

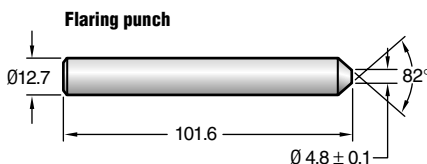

PART NUMBER
54-0-5467-11 •

Material
Hardened steel.

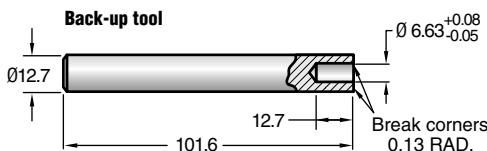

PART NUMBER
54-0-5466-11 •

Material
Hardened steel.



To Captivate Screw

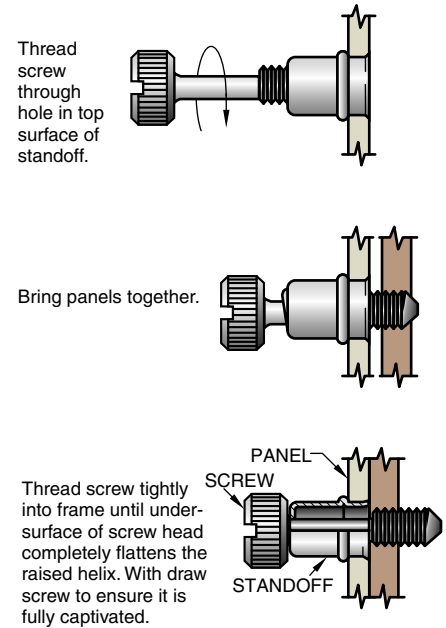

Material and Finish

SCREWS: 302 Stainless steel.

STANDOFFS: 305 Stainless steel.

BOTH PARTS are passivated or are passivated plus black organic coating.

NOTE: Each part number represents a screw and standoff shipped **unassembled**, protectively packaged (bright standoffs are bulk packaged).

NOTE: Longer screw lengths and unslotted head styles are available on special order.

millimeter (inch)
millimeter
(inch)

Dimensions without tolerances are for reference only.

Captive Fasteners
Captive Screws

Southco® Captive Fasteners

Polished Series, 4-40 and 6-32 Thread

- Simple design
- Highly polished appearance

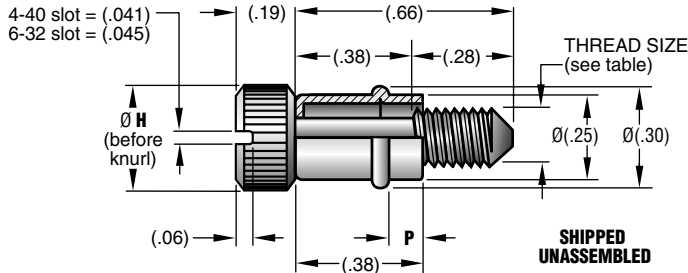

To Captivate Screw

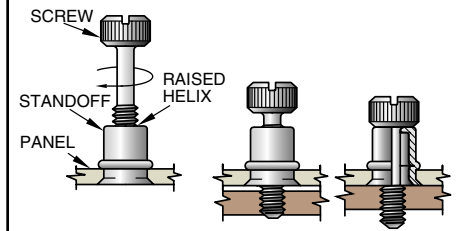

1. Thread screw through hole in top surface of standoff.
2. Bring panels together. Thread screw tightly into frame until under surface of screw head completely flattens the raised helix. Withdraw screw to ensure it is fully captivated.

Material and Finish

NO. 4 SCREW: 303 Stainless steel
 NO. 6 SCREW: 302 Stainless steel.
 STANDOFF: 305 Stainless steel.
 SCREWS and STANDOFFS are passivated.
 BLACK screw assemblies have black organic coating.

Fasteners are ordered by their assembly part number but are shipped and identified as components of the finished assembly.

To Install Standoff

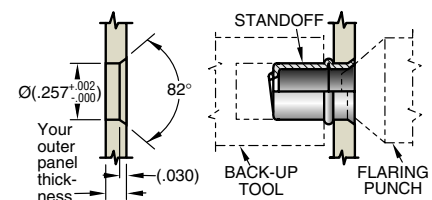

1. Prepare panel.
2. Insert standoff into hole and flare into countersink as shown.

millimeter (inch)
 millimeter
 (inch)

Dimensions without tolerances are for reference only.

BLACK screw assemblies

OUTER PANEL THICKNESS			4-40	6-32	P
MIN.	NOM.	MAX.	Ø H = (.31)	Ø H = (.31)	
(.05)	(.06)	(.07)	51-10-406-26	51-18-406-26	(.06)
(.08)	(.09)	(.10)	51-10-506-26	51-18-506-26	(.09)
(.11)	(.12)	(.13)	51-10-606-26	51-18-606-26	(.13)

BRIGHT POLISHED screw assemblies

OUTER PANEL THICKNESS			4-40	6-32	P
MIN.	NOM.	MAX.	Ø H = (.31)	Ø H = (.31)	
(.05)	(.06)	(.07)	51-10-406-24 •	51-18-406-24 •	(.06)
(.08)	(.09)	(.10)	51-10-506-24 •	51-18-506-24 •	(.09)
(.11)	(.12)	(.13)	51-10-606-24 •	51-18-606-24 •	(.13)

Standoff Installation Tools (order separately).

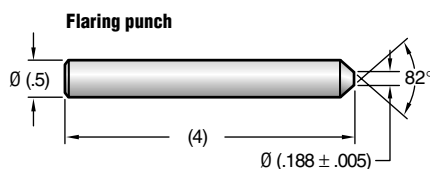

PART NUMBER
 54-0-5467-11 •

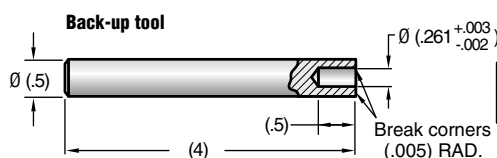

PART NUMBER
 54-0-5466-11 •

Material
 Hardened steel.

Material
 Hardened steel.

Southco® Captive Fasteners

Polished Series, M4, M5, and M6 Thread

- Simple design
- Highly polished appearance

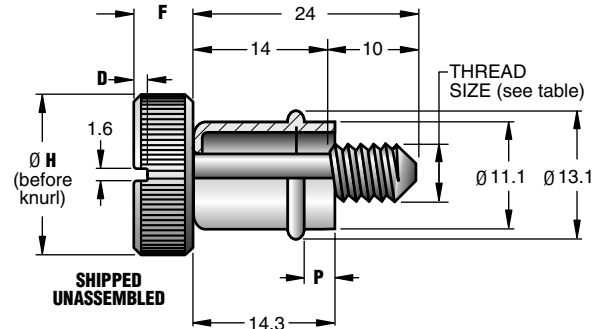

DIMENSIONS				THREAD SIZE	PART NUMBERS
P	Ø H	D	F		

BLACK screw assemblies

3.2				M4 X 0.7	51-74-714-26
4.8	10.3	1.6	6.0	M4 X 0.7	51-74-814-26
6.3				M4 X 0.7	51-74-914-26
3.2				M5 X 0.8	51-76-714-26
4.8	11.1	1.6	6.3	M5 X 0.8	51-76-814-26
6.3				M5 X 0.8	51-76-914-26
3.2				M6 X 1.0	51-77-414-26
4.8	14.3	2.3	6.3	M6 X 1.0	51-77-514-26
6.3				M6 X 1.0	51-77-614-26

BRIGHT POLISHED screw assemblies

3.2				M4 X 0.7	51-74-714-24•
4.8	10.3	1.6	6.0	M4 X 0.7	51-74-814-24•
6.3				M4 X 0.7	51-74-914-24•
3.2				M5 X 0.8	51-76-714-24•
4.8	11.1	1.6	6.3	M5 X 0.8	51-76-814-24•
6.3				M5 X 0.8	51-76-914-24
3.2				M6 X 1.0	51-77-414-24•
4.8	14.3	2.3	6.3	M6 X 1.0	51-77-514-24•
6.3				M6 X 1.0	51-77-614-24•

Each part number represents a screw and standoff shipped unassembled, protectively packaged (bright standoffs are bulk packaged).

To Select Proper Screw Assembly

1. Measure your outer panel thickness and enter SCREW ASSEMBLY SELECTION TABLE (right) with your thickness.
2. Read across to find **P** dimension and installation method (A or B).
3. Enter ASSEMBLY PART NUMBER TABLE (right) with your **P** dimension, at section having your desired thread size, and read across to find correct assembly part number.

To Captivate Screw

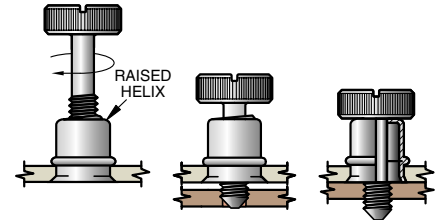

1. Thread screw through hole in top surface of standoff.
2. Bring panels together.
3. Thread screw tightly into frame until under-surface of screw head completely flattens the raised helix. Withdraw screw to ensure it is fully captivated.

Your Outer Panel Thickness		Select an assembly with P dim. of:	Use this installation method
MIN.	MAX.		
1.6	1.9	3.2	B
2.3	3.6	4.8	B
2.8	3.6	3.2	A
3.9	5.2	6.3	B
4.4	5.2	4.8	A
5.9	6.7	6.3	A

Material and Finish

SCREWS: 302 Stainless steel.

STANDOFFS: 305 Stainless steel.

BOTH PARTS are passivated or are passivated with black organic coating.

To Install Standoff

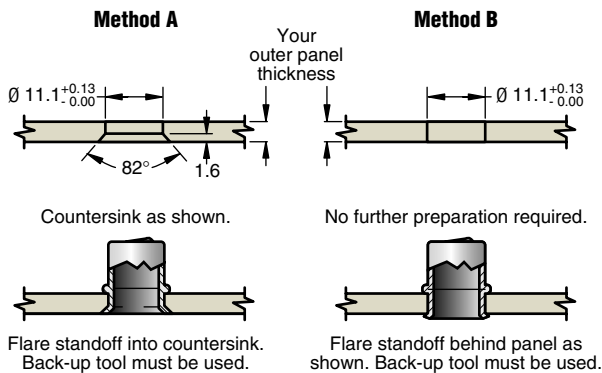

Standoff Installation Tools

(Order separately)

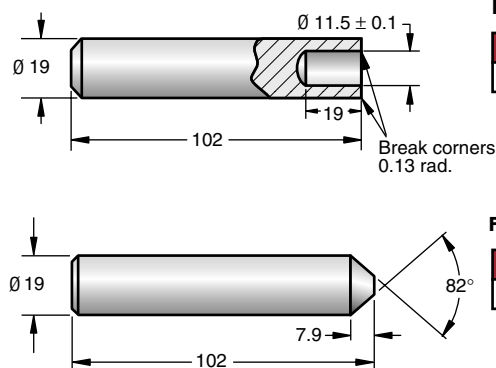

Back-up tool

PART NUMBER
90-2825-11

Material
Mild steel.

Flaring punch

PART NUMBER
90-2824-11

Material
Hardened steel.

millimeter (inch)
millimeter
(inch)

Dimensions without tolerances are for reference only.

Captive Fasteners
Captive Screws

Southco® Captive Fasteners

**Polished Series,
8-32, 10-32 and 1/4-20 Thread**

- **Simple design**
- **Highly polished appearance**

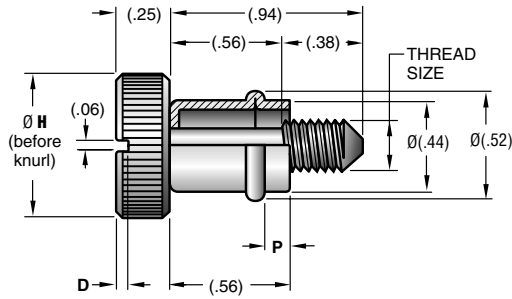
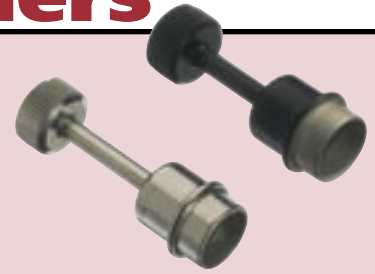

ØH	D
(.69)	(.13)
(.56)	(.09)
(.44)	(.06)

To Captivate Screw

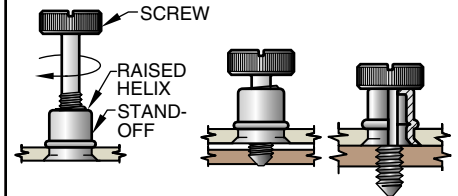

1. Thread screw through hole in top surface of standoff.
2. Bring panels together.
3. Thread screw tightly into frame until under surface of screw head completely flattens the raised helix. Withdraw screw to ensure it is fully captivated.

Material and Finish

SCREWS: 302 Stainless steel.
STANDOFFS: 305 Stainless steel.
SCREWS and STANDOFFS are passivated or are passivated and have black organic coating.

TO SELECT PROPER SCREW ASSEMBLY

1. Measure your outer panel thickness and enter table (below) with your thickness.
2. Read across to find **P** dimension and installation method (A or B).
3. Enter part number table with your **P** dimension and read across to find correct assembly part number under head and thread size desired.

Outer Panel Thickness		Select an assembly with P dim. of:	Use this installation method
MIN.	MAX.		
(.06)	(.08)	(.13)	B
(.09)	(.14)	(.19)	B
(.11)	(.14)	(.13)	A
(.16)	(.20)	(.25)	B
(.17)	(.20)	(.19)	A
(.23)	(.27)	(.25)	A

To Install Standoff

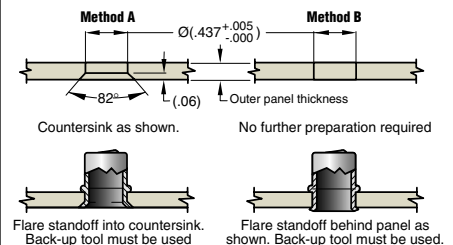

millimeter (inch)
millimeter
(inch)

Dimensions without tolerances are for reference only.

Slotted BLACK screw assemblies

P	Ø H = (.44)		Ø H = (.56)	Ø H = (.69)
	8-32	10-32	1/4-20	1/4-20
(.13)	51-17-709-26	51-16-709-26	51-11-409-26	51-11-109-26
(.19)	51-17-809-26	51-16-809-26	51-11-509-26	51-11-209-26
(.25)	51-17-909-26	51-16-909-26	51-11-609-26	51-11-309-26

Slotted BRIGHT POLISHED screw assemblies

P	Ø H = (.44)		Ø H = (.56)	Ø H = (.69)
	8-32	10-32	1/4-20	1/4-20
(.13)	51-17-709-24 •	51-16-709-24 •	51-11-409-24 •	51-11-109-24 •
(.19)	51-17-809-24 •	51-16-809-24 •	51-11-509-24 •	51-11-209-24 •
(.25)	51-17-909-24 •	51-16-909-24 •	51-11-609-24 •	51-11-309-24 •

Standoff Installation Tools

(Order separately)

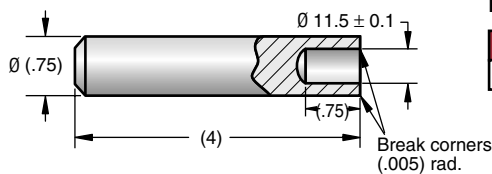

Back-up tool

PART NUMBER
90-2825-11

Material
Mild steel.

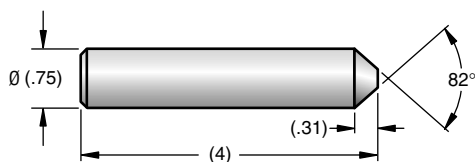

Flaring punch

PART NUMBER
90-2824-11

Material
Hardened steel.

Southco® Captive Fasteners

Basic Series

- Generous knob for hand operation
- Highly polished appearance
- Captivated by retainer

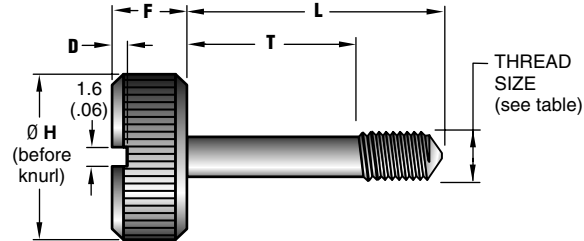

Ø H	D	F
14.3 (.56)	1.3 (.09)	6.3 (.25)
11.1 (.44)	1.6 (.06)	6.3 (.25)
10.3 (.41)	1.6 (.06)	6.0 (.24)



English Thread Sizes

Dimensions		PART NUMBERS		
		Ø H = 11.1 (.44)	Ø H = 14.3 (.56)	
L	T	8-32	10-32	1/4-20
24 (.94)	14 (.56)	58-27-309-24	58-26-309-24	58-21-209-24
25 (1.00)	16 (.63)	58-27-310-24	58-26-310-24	58-21-210-24
27 (1.06)	17.5 (.69)	58-27-311-24	58-26-311-24	58-21-211-24
28.6 (1.13)	19 (.75)	58-27-312-24	58-26-312-24	58-21-212-24
30.2 (1.19)	20.6 (.81)	58-27-313-24	58-26-313-24	58-21-213-24
31.8 (1.25)	22.2 (.88)	58-27-314-24	58-26-314-24	58-21-214-24
33.3 (1.31)	23.8 (.94)	58-27-315-24	58-26-315-24	58-21-215-24
35 (1.38)	25.4 (1.00)	58-27-316-24	58-26-316-24	58-21-216-24

Note: For screws with BLACK Finish, change the last digit of your Part Number from a "4" to a "6".

Example: 58-27-309-26

Metric Thread Sizes

Dimensions		Ø H = 10.3 (.41)	Ø H = 11.1 (.44)	Ø H = 14.3 (.56)
L	T	M4 x 0.7	M5 x 0.8	M6 x 1.0
24 (.94)	14 (.55)	58-74-314-24	58-76-314-24	58-77-214-24
26 (1.02)	16 (.63)			58-77-216-24

Panel Preparation

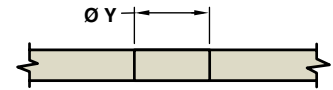

THREAD SIZE	Ø Y	THREAD SIZE	Ø Y
No. 8-32	(.170)	M4 x 0.7	4.5
No. 10-32	(.196)	M5 x 0.8	5.5
1/4-20	(.257)	M6 x 1.0	6.6

Split Ring Retainer

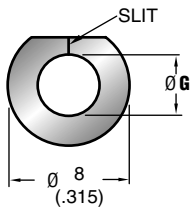

Screw Thread Size	Ø G	PART NUMBER
M4 x 0.7	3.5	58-45-5-24
No. 8-32	(.139)	
M5 x 0.8	4.2	58-42-5-24
No. 10-32	(.165)	
M6 x 1.0	5.1	58-41-2-24
1/4-20	(.202)	

Installation Tool (order separately)

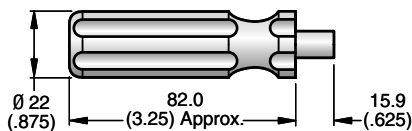

PART NUMBER
29-53-101-10

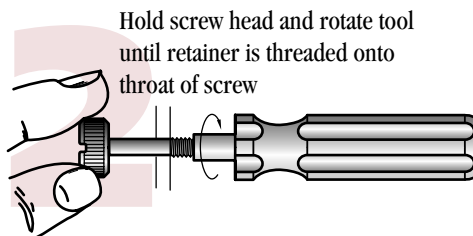
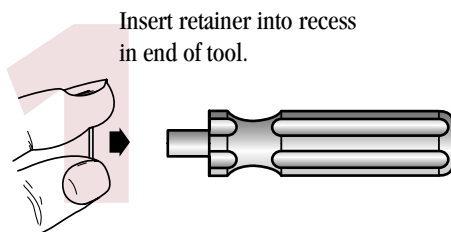

Material and Finish

SCREW: 302 Stainless steel, passivated.
BLACK screws have black organic coating.

RETAINERS: 302 Stainless steel, passivated.

millimeter (inch)
millimeter
(inch)

Dimensions without tolerances are for reference only.