

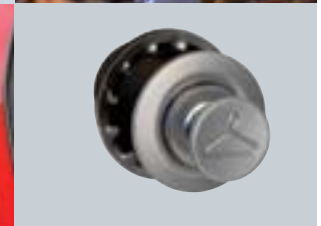

Engineered Access Solutions
for the **Aerospace Industry**



SOUTHCO

solutions for the Aerospace industry

From cockpit to cabin, Southco offers a comprehensive product portfolio of latching, fastening and positioning technologies for a wide range of interior and exterior aircraft applications.

Our broad offering of engineered access solutions meets Aerospace industry requirements for strength, durability and compliance, enhances passenger comfort, and provides an extra layer of safety and security.



SOUTHCO

programme management from concept to production

■ Southco provides total programme management, from initial design and prototyping to manufacturing and logistics:

- Engineer-to-engineer connectivity
- Off-the-shelf solutions suitable for high and low volume production
- Industry standard products to meet global compliance specifications
- Innovative product design and development
- Global supply and manufacturing presence with localised support
- Continuous improvement for defect-free manufacturing and on-time delivery



SOUTHCO

aviation comfort, security and efficiency

■ Southco products offer proven reliability and seamlessly integrate into Aerospace applications:

- Positioning Hinges and Display Mounting solutions improve the passenger experience
- Electronic Access Solutions increase cabin security and safety
- Push-to-Close Latches offer secure latching with visible and concealed mounting styles
- Multi-Point Latching Systems accommodate door misalignment and provide flexible actuation options
- Draw and Compression Latches offer resilience and vibration resistance
- *DZUS*® Quick Access Fasteners enable easy maintenance and offer high cycle life
- *LOCKWELL*® Quick Release Pins offer dependable, fast removal for interior and exterior use

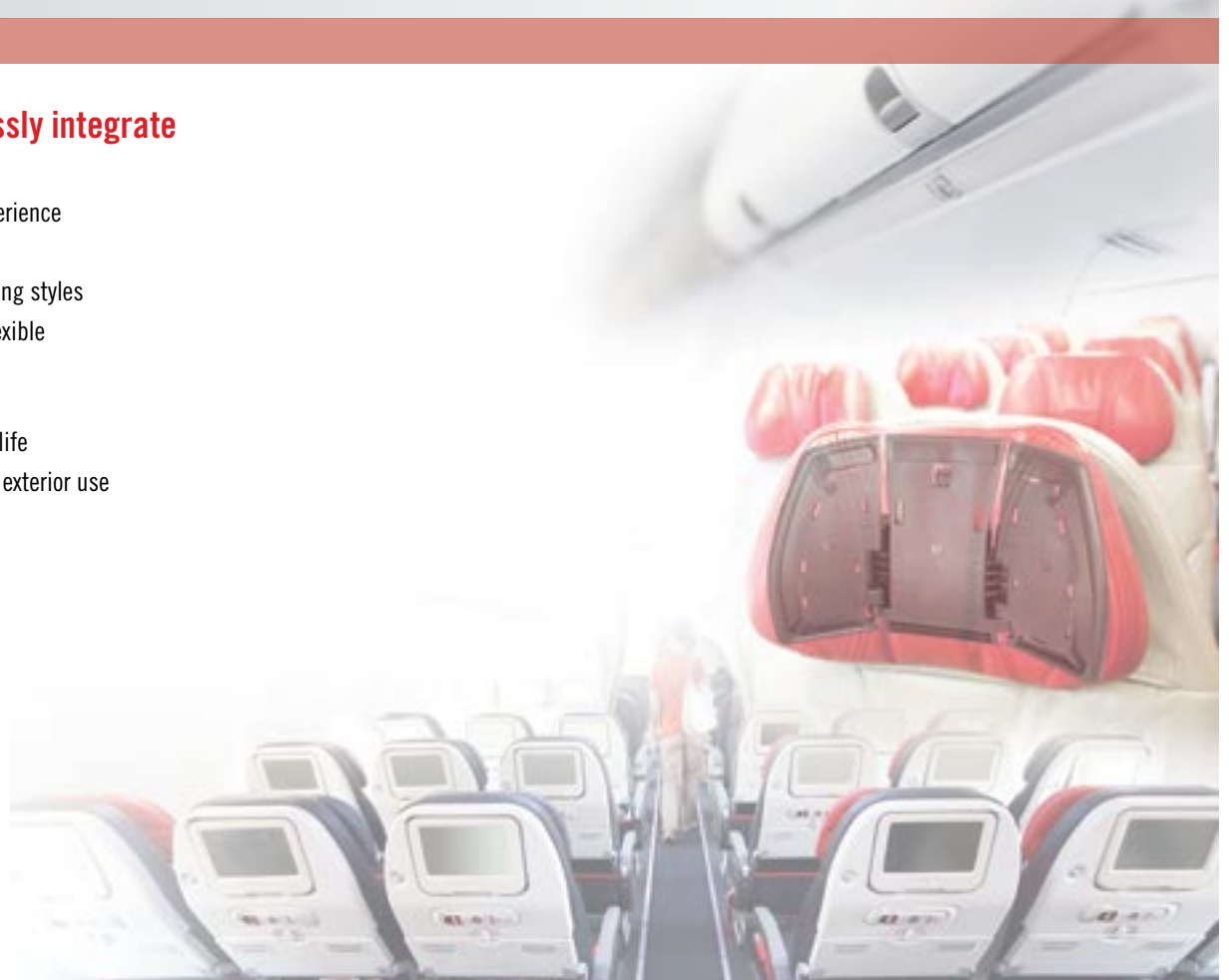

DZUS®

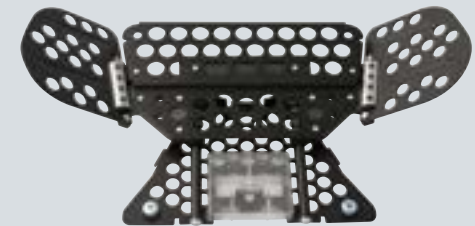

Positioning Technology Solutions

Southco's line of Positioning Hinges and Display Mounts ensure functionality and promote passenger comfort in cabin applications, enhancing ergonomics and usability.

- Integrated torque hinges allow the end user to easily adjust headrest wings, yet support full head weight
- Friction hinges enable lightweight access panels to feel heavier and more substantial
- Display mounting options support inflight entertainment (IFE) systems, whether positioning a screen from the headrest or armrest

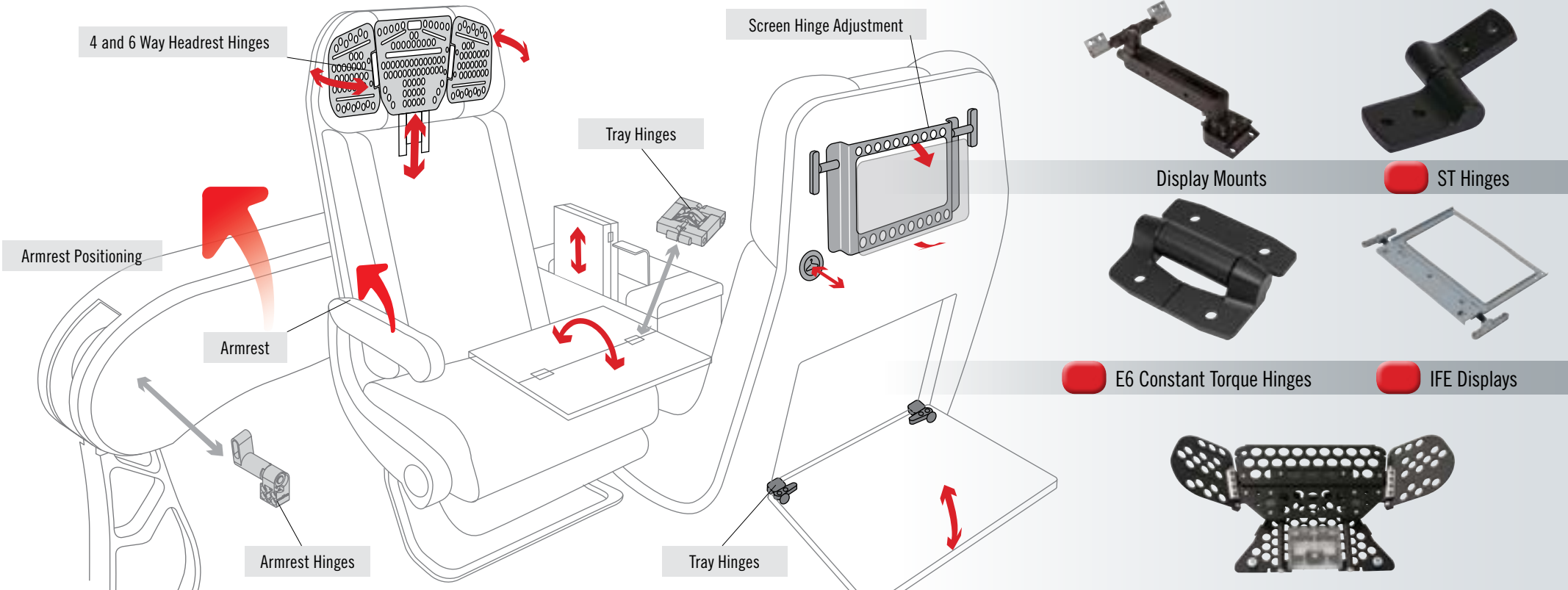



■ Electronic Access Solutions

Southco's Electronic Access Solutions improve safety and security across the aircraft. Intelligent electronic locks provide reliable, secure latching, and remote access and control.

- Keep access points secure during take-off, taxi and landing, or turbulence
- Allow flight crew to remotely control passengers' access to overhead luggage bins, lavatories or food trays
- Secure access to lifesaving devices and release in emergency situations

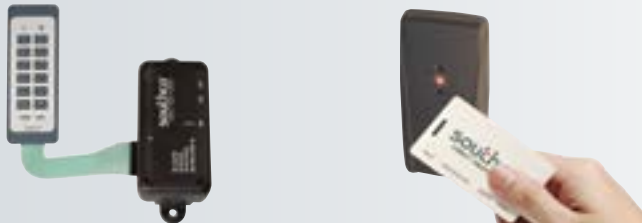

Electronic Access Control



Electronic Keepers



Mini Motor Actuators

Electronic Rotary Latches

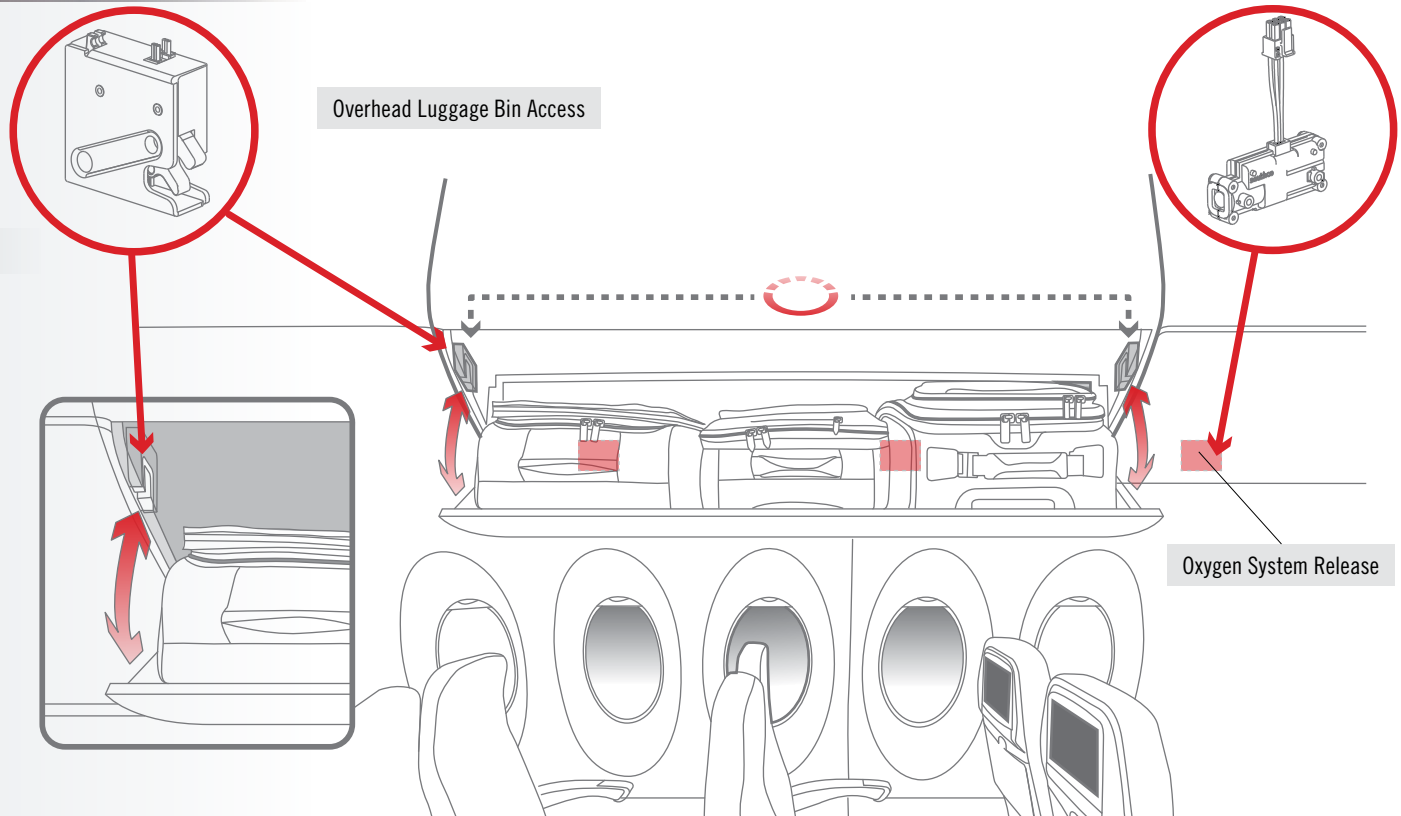

SOUTHCO

a wide range of solutions

■ Southco's wide range of products for the Aerospace industry includes:

- Electronic Access Solutions
- Positioning Technology & Hinges
- Push-to-Close Latches
- Compression Latches
- Draw Latches
- Multi-Point Latching Systems
- *DZUS*[®] Quarter-Turn Fasteners
- *LOCKWELL*[®] Quick Release Pins

Application Areas

Passenger Seating · Under-seat Storage · Overhead Bins · Inflight Entertainment Systems · Galley Equipment
Lavatory and Cabin Units · Utility/Cabinet Drawers · Cockpit Instruments · Avionics Panels · Lighting Fixtures · AC Channels
Cargo Liners · Engine Cowling · Thrust Reverse Structures · Aircraft Tow Tugs · Landing Gear

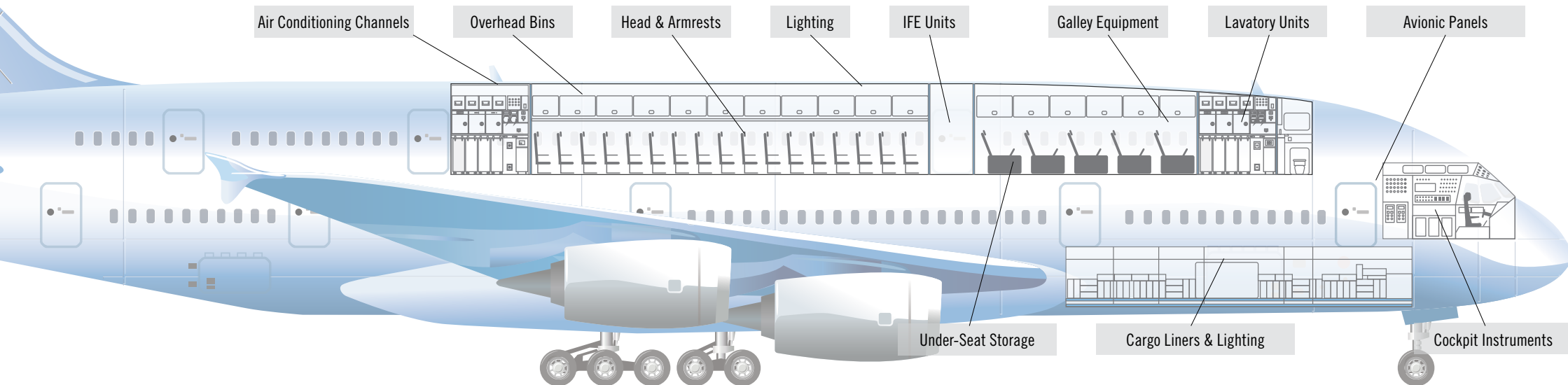
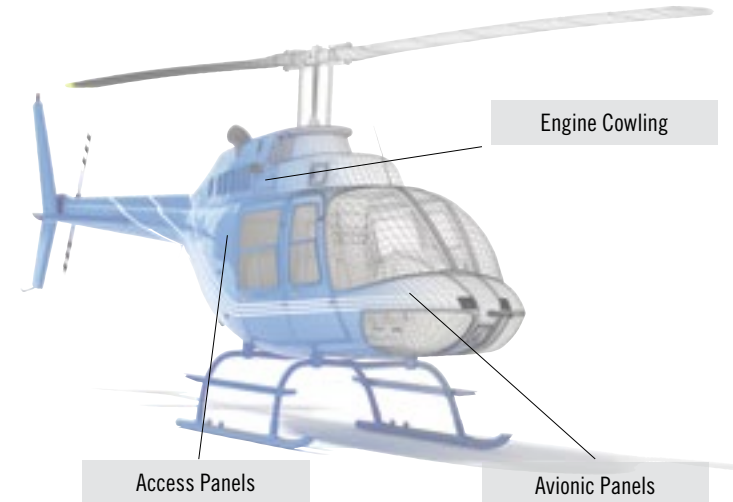

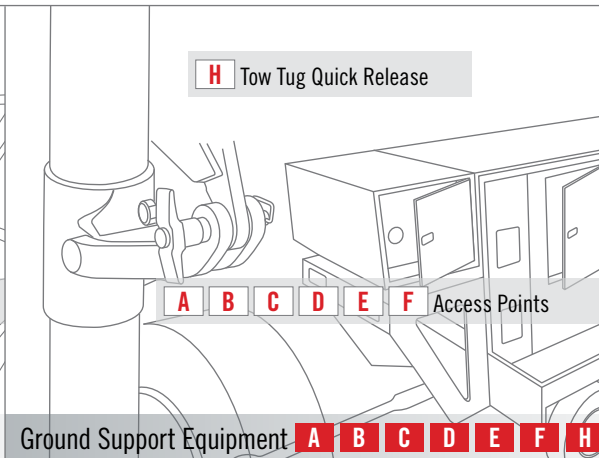
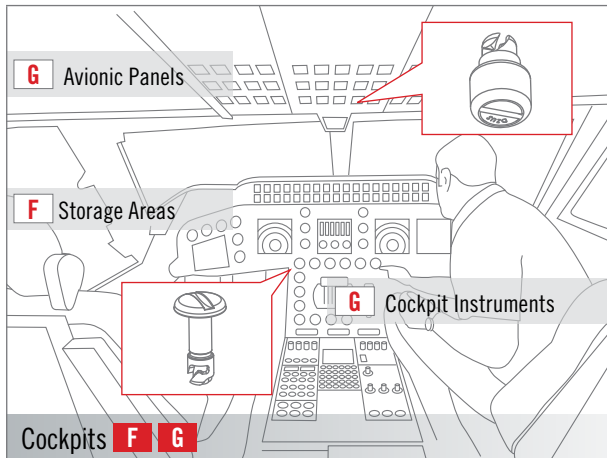
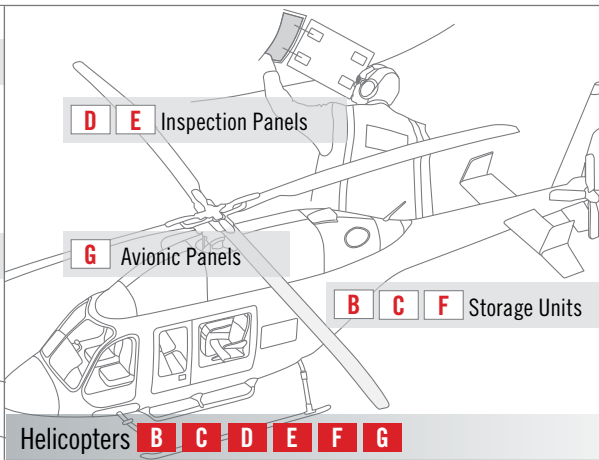
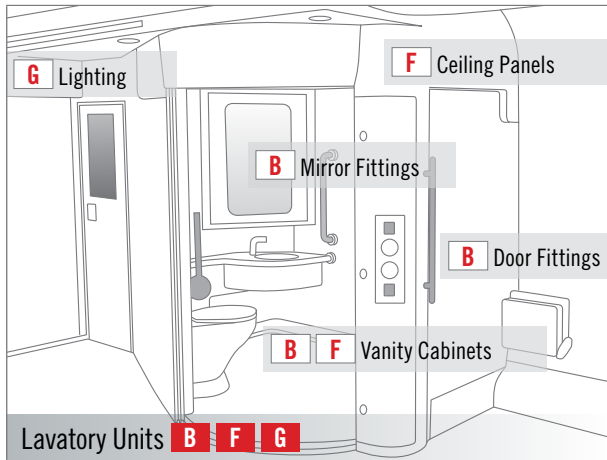
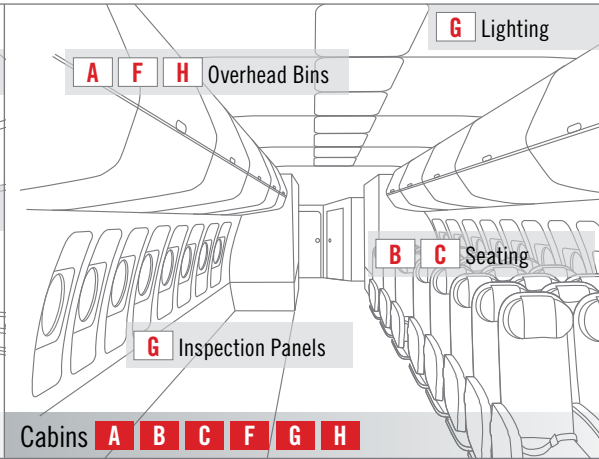
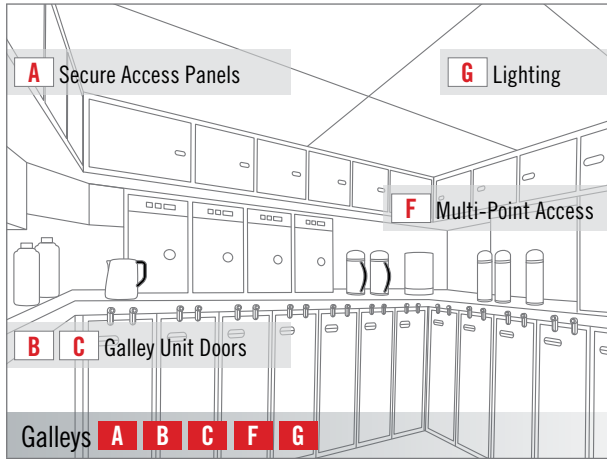

SOUTHCO

a wide range of products

A Electronic Access



B Positioning Technology & Hinges



C Push-to-Close Latches



D Compression Latches



E Draw Latches



F Multi-Point Latching Systems



G DZUS® Quarter-Turn Fasteners



H LOCKWELL® Quick Release Pins



SOUTHCO

your Aerospace solutions partner

■ Southco is a trusted design partner and supplier to the Aerospace industry, offering validated solutions and engineering expertise with regard to:

- Maximising the passenger flight experience
- Supporting crew in performing service tasks safely and securely
- Optimising maintenance procedures
- Complementing aircraft studio interior styling
- Meeting Aerospace quality and production standards

Integrating access hardware and positioning technology into aircraft interior applications such as seating, access paneling, lavatories, carts and galleys improves usability, safety and reliability for passengers and crew.



Open a world of possibilities

Global Corporate Headquarters & Customer and Technical Support Centre

Concordville, PA · USA

Tel: (1) 610 459 4000

Fax: (1) 610 459 4012

Canada Tel: (1) 905 855 0309

Mexico Tel: (1) 877 821 0666

Southco Unikey

Cotia, SP · Brazil

Tel: (5511) 4617 4112

Fax: (5511) 4612 2293

Manufacturing & Stocking Locations

Chihuahua · Mexico

Concordville · Pennsylvania

Philadelphia · Pennsylvania

Honeoye Falls · New York

São Paulo · Brazil

Tecate · Mexico

Europe Customer & Technical Support Centre

Worcester · UK

Tel: (44) (0) 1905 346722

Fax: (44) (0) 1905 346723

Austria Tel: 0800 281 831

France Tel: 0800 912 756

Germany Tel: 0800 1800 380

Italy Tel: 800 780 953

Spain Tel: 900 968917

Sweden Tel: 020 790 366

UK & NI Tel: 0845 117 9222

Manufacturing & Stocking Locations

Farnham · UK

Worcester · UK

Asia Customer & Technical Support Centre

Hong Kong · China

Tel: (852) 3127 1503

Fax: (852) 3127 1541

China Tel: 800 820 0272

Korea Tel: 0505 777 1234

Malaysia Tel: 1800 801 119

Singapore Tel: 800 18 11016

Taiwan Tel: 0800 558 015

Australia Customer Service & Distribution Centre

Tullamarine · Victoria 3043 · Australia

Tel: (61) 03 9330-5000 · Fax: (61) 03 9330 - 5099

India Customer Service & Technical Support Centre

Taluka Shirur · Pune 412208 · India

Tel: (91) (21) 3867 0538 · Fax: (91) (21) 3867 0588

Japan Customer Service & Distribution Centre

Konohana-ku · Osaka 554-0024 · Japan

Tel: (81) 6 6466 1200 · Fax: (81) 6 6466 1205

Manufacturing & Stocking Locations

Hong Kong · China

Seoul · South Korea

Melbourne · Australia

Shanghai · China

Pune · India

Shenzhen · China

Industry Minisites

Product Minisites



Blog



Southco



@southcoinc

