



**POSITIONING
TECHNOLOGY**

Refined control for intuitive,
ergonomic operation

WHY USE SOUTHCO'S POSITIONING HINGES?

Southco Positioning Hinges allow users the flexibility to define and adjust the operating effort required to move or position doors, display screens, safety shields and other mounted components, and hold them securely at any desired angle. Multiple hinge sizes, materials and torque ranges provide the options to satisfy a wide range of application needs.

Our Positioning Hinges enable you to:

- Hold doors opened or closed and move panels securely into position without secondary supports
- Create an intuitive zero-drift solution that holds a user- or pre-defined position secure
- Eliminate gas struts needed to hold doors open and latch points to keep them closed
- Implement a high-quality, reliable, maintenance-free solution



Calculate the necessary torque using our iPad app. at southco.com/positioncontrol

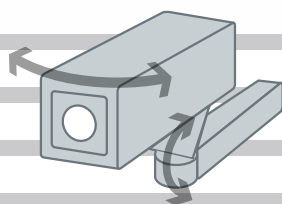

CCTV & Cameras

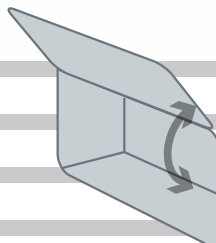

Panels & Doors

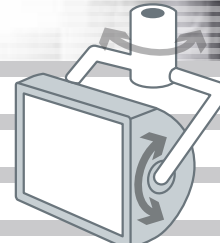

Lighting

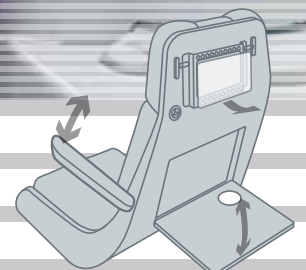

Seating

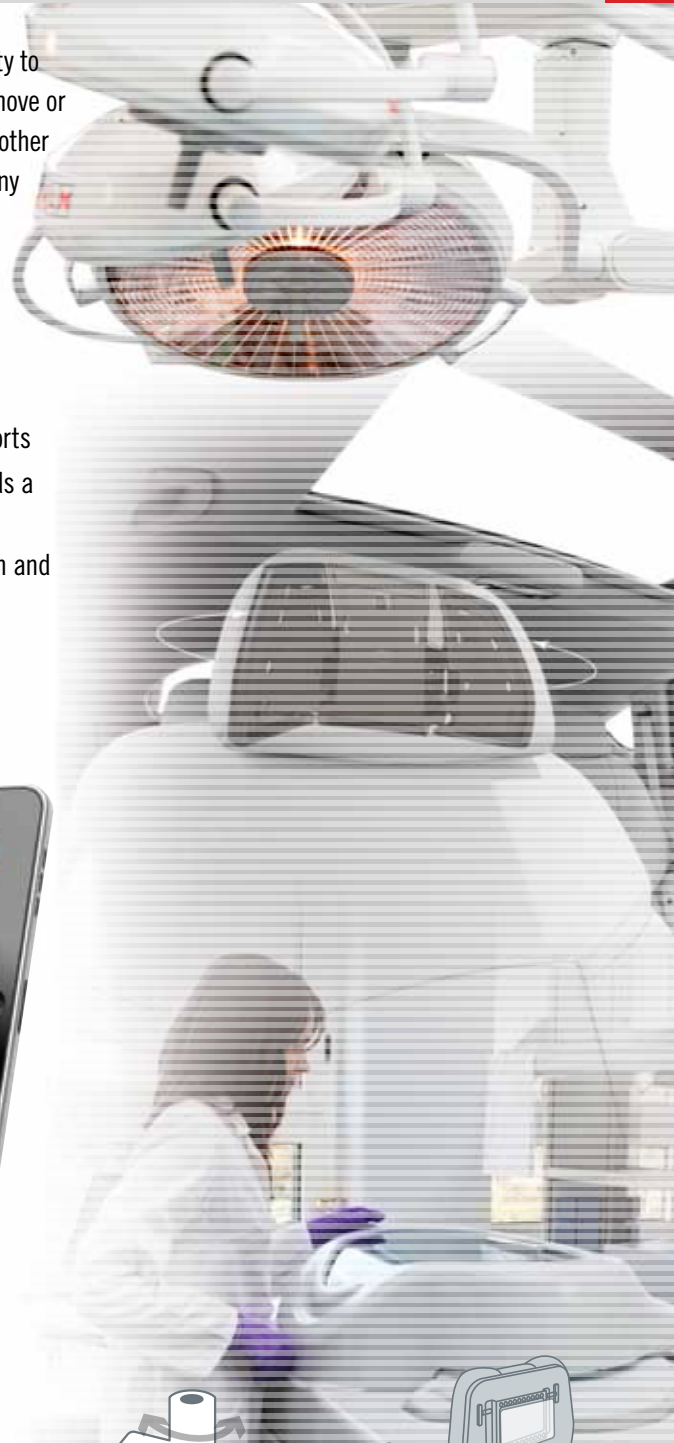

WHY USE SOUTHCO'S DISPLAY POSITIONING SOLUTIONS?

Southco Display Positioning Solutions deliver smooth, secure positioning of monitors and display screens to improve the end user experience – providing optimal ergonomics. The precise resistance levels, long life and controlled motion of Southco's display arms and tilt/swivel devices enable quick and easy adjustments that can be made without tools, allowing the user to angle screens to compensate for individual height differences or glare from changing light sources.

Our Display Positioning Solutions enable you to:

- Position and reposition a display screen or touchscreen to improve end user experience
- Create an intuitive zero-drift solution without additional adjustment
- Maintain a user-defined position, even under vibration impact
- Counterbalance a heavy screen to lighten operation
- Manage cables discreetly
- Integrate our products into your design, enhancing equipment appearance and functionality

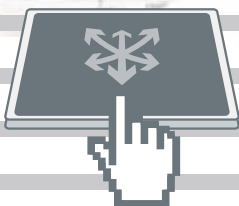

Monitors & Screens

Touchscreens

Laptops

VESA Compliant



PRODUCT OVERVIEW

POSITIONING HINGES FROM SOUTHCO



Southco's line of Positioning Hinges offer standard solutions for external, concealed or fully integrated designs requiring repositioning and control of motion. Our hinging technology is scalable to suit any torque requirement and packaging space, allowing the flexibility to create a customized hinge for your application.



Constant

- Provides constant resistance throughout the entire range of motion
- Preset in our manufacturing facility and never requires adjustment
- Zero-drift and backlash, even under vibration or dynamic loads
- Available with asymmetric torque for simplified operation

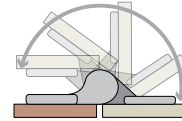

Adjustable

- Allows the end user to easily adjust operating effort
- Enables one product to be used across multiple, varying applications
- Symmetric torque delivers the same operating effort for opening/closing direction

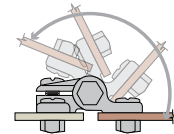

Counterbalance

- Allows weight of an object to be offset in one direction for a limited range of motion
- Assists heavy panel lifting and enables self-opening



Detent and Bistable

- Provides additional resistance at pre-determined angles
- Preset in our manufacturing facility, locking into place every time
- Can be customized for specific angle and breakaway load requirements

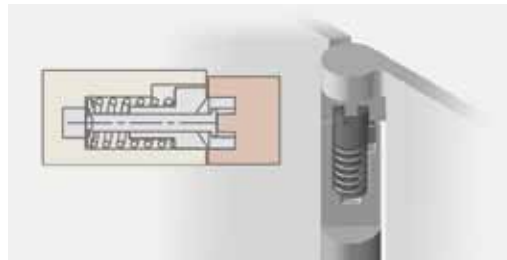

POSITIONING TECHNOLOGY



PRODUCT OVERVIEW

DISPLAY MOUNTING FROM SOUTHCO



Our positioning arms and display mounts are VESA compliant for 12" to 23" (75 and 100 mm pattern) monitors, feature zero-drift, grab-and-position operation and eliminate the need for constant readjustment and maintenance when repositioning.



Tilt Display Mount

- Provides vertical angle adjustment of the display or touchscreen
- Precision tilt feature enables effortless display positioning and infinite angle options
- Enclosed counterbalance enables easy cleaning and upkeep
- Reliable, repeatable cycle life eliminates the need for service or adjustment

Tilt and Swivel Display Mount

- Tilts both vertically and horizontally
- Both axes are configured for light, yet robust operation
- Precisely controlled operating efforts within the joints prevent drift in the display
- Range of motion stops for added flexibility



Tilt, Swivel and Swing Out Arm

- Incorporates tilt, swivel and full swing out functionalities for dynamic mounting options
- The robust arm folds within 50 mm of the wall and uses minimal space in a stored position
- Customizable to suit precise, unique operating effort
- Clean appearance with integrated cable management covers



Customized Multi-Axis Mounting Arms

- Aesthetics designed to suit custom color and appearance preferences
- Different ranges of motion for even the most challenging applications
- Scalable for heavy weight displays and increased lengths required for operation
- Various custom mounting options available

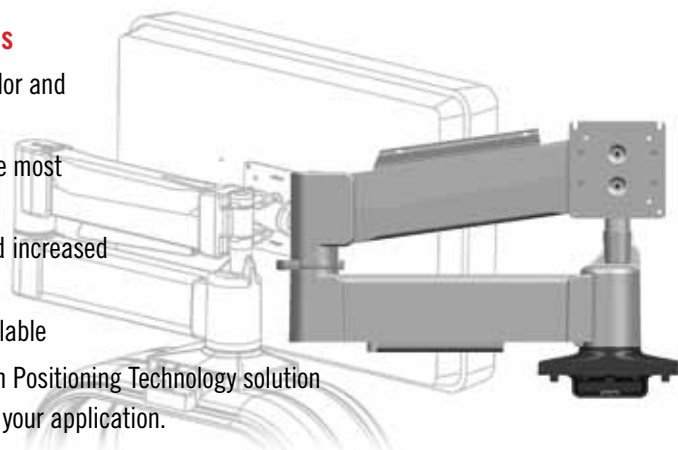

Our engineers are ready to design a custom Positioning Technology solution to meet the unique design requirements of your application.

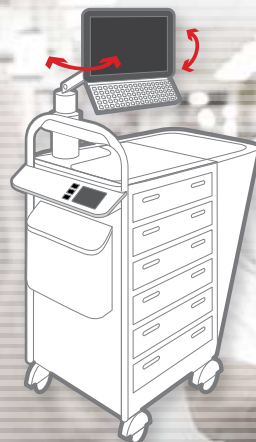
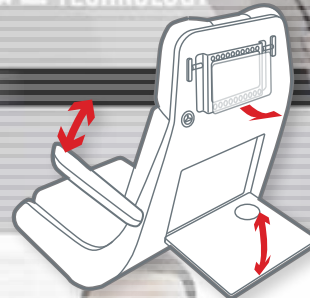
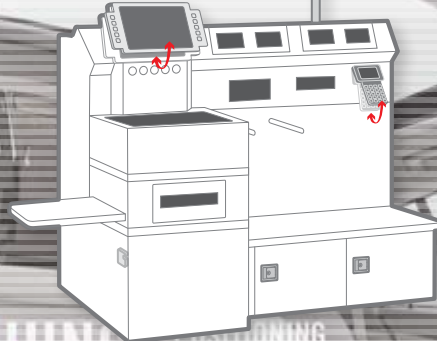
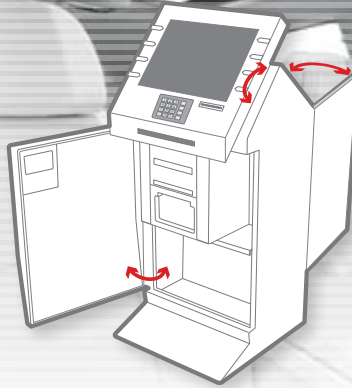

THE PROVEN GLOBAL LEADER IN ENGINEERED ACCESS AND POSITIONING SYSTEMS



Global Corporate Headquarters & Customer and Technical Support Center

Concordville, PA · USA

Tel: (1) 610 459 4000

Fax: (1) 610 459 4012

Canada Tel: (1) 905 855 0309

Mexico Tel: (1) 877 821 0666

Manufacturing & Stocking Locations

Chihuahua, Mexico

Concordville, Pennsylvania

Honeoye Falls, New York

Tecate, Mexico

Rockledge, Florida

European Customer & Technical Support Center

Worcester · UK

Tel: (44) (0) 1905 346722

Fax: (44) (0) 1905 346723

Austria Tel: 0800 281 831

France Tel: 0800 912 756

Germany Tel: 0800 1800 380

Italy Tel: 800 780 953

Spain Tel: 900 968917

Sweden Tel: 020 790 366

UK & NI Tel: 0845 117 9222

Manufacturing & Stocking Locations

Farnham, UK

Worcester, UK

Asia Pacific Customer & Technical Support Center

Hong Kong · China

Tel: (852) 3127 1503 · Fax: (852) 3127 1541

China Tel: 800 820 0272

Japan Tel: 00531 121672

Korea Tel: 0505 777 1234

Malaysia Tel: 1800 801 119

Singapore Tel: 800 18 11016

Taiwan Tel: 0800 558 015

Australia Customer Service and Distribution Center

Tullamarine · Victoria 3043 · Australia

Tel: (61) 03 9330-5000 · Fax: (61) 03 9330 - 5099

India Customer Service and Technical Support Center

Taluka Shirur · Pune 412208 · India

Tel: (91) (21) 3867 0538 · Fax: (91) (21) 3867 0588

Manufacturing & Stocking Locations

Hong Kong, China

Shanghai, China

Shenzhen, China

Melbourne,

Australia

Pune, India

Seoul, South Korea

Tokyo, Japan

