



# TL Draw Latch

Over-center · Small · Wire bail

- Compact latch
- Multiple link options for application variances

### Material and Finish

Stainless steel, steel, zinc plated or steel, black E-coat

### Performance Details

Steel working load:

Compact heavy-duty:

1290 N (290 lbf)

Compact: 220 N (45 lbf)

Stainless steel working load:

Compact heavy-duty:

800 N (180 lbf)

Compact: 220 N (45 lbf)

### Installation Notes

Install assembly with M4 (No. 6) round head screws (not supplied) or 4 (.156) rivets

### Notes

Order keepers separately, see page 210

### Exposed Mounting Holes

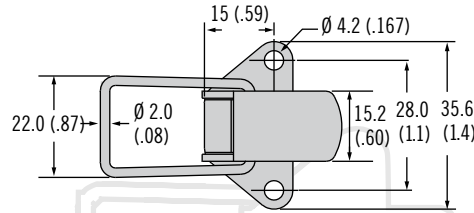

### Heavy-Duty

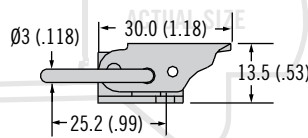

### Flat Wire Link

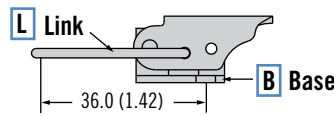

### Short Curved Wire Link

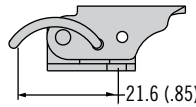

### Long Curved Wire Link

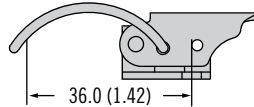

### Shallow Hook Link

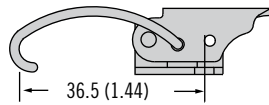

### Deep Hook Link

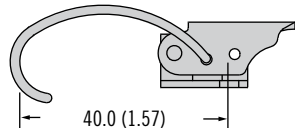

### Concealed Mounting Holes

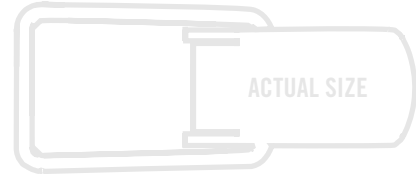
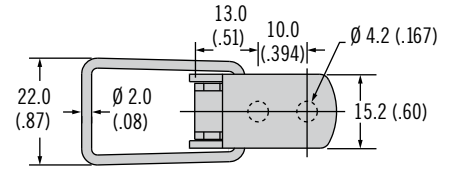

### Flat Wire Link

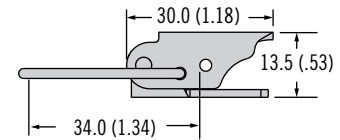

### Short Curved Wire Link

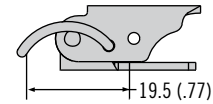

### Long Curved Wire Link

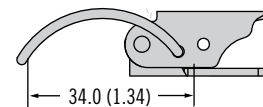

### Shallow Hook Link

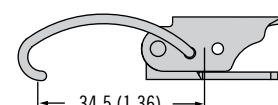

### Deep Hook Link

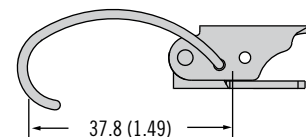

### Part Number Selection

Latch only

See page 210 for keepers

#### L Link style

- 1 Flat
- 2 Short curved
- 3 Long curved
- 4 Shallow hook
- 5 Deep hook
- 6 Heavy-duty (Steel & 300 stainless steel model only)

TL - 20 - B 0 L - F

#### B Base type

- 1 Exposed
- 2 Concealed

#### F Finish

- 07 Steel, zinc plated
- 13 Black E-coat
- 24 316 stainless steel electropolished
- 52 300 stainless steel passivated

Dimensions in millimeters (inch) unless otherwise stated



[www.southco.com/TL](http://www.southco.com/TL)

# TL Draw Latch

Over-center · Medium · Wire bail



## Exposed Mounting Holes

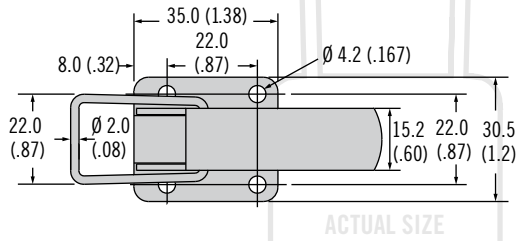

## Concealed Mounting Holes

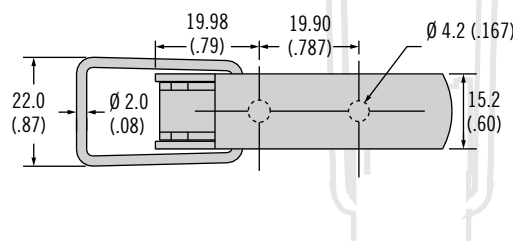

## Flat Wire Link

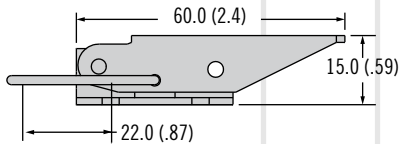

## Flat Wire Link

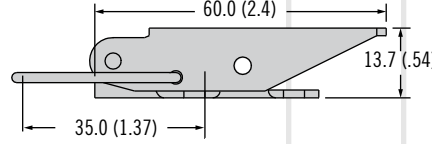

## Curved Wire Link

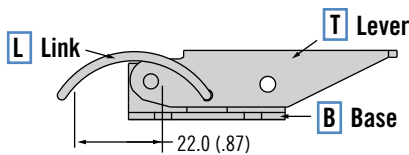

## Curved Wire Link

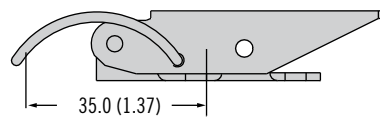

## Shallow Hook Link

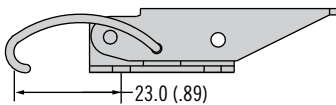

## Shallow Hook Link

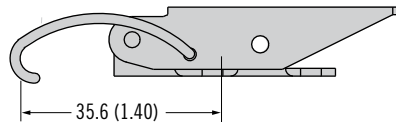

## Deep Hook Link

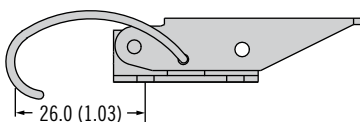

## Deep Hook Link

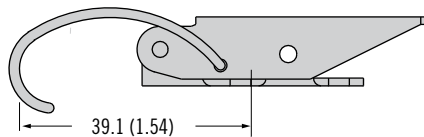

- Multiple link options for application variances
- Secondary locking style available

## Material and Finish

Stainless steel or steel, zinc plated or steel, black E-coat

## Performance Details

Steel:

Working load: 220 N (45 lbf)

Stainless Steel:

Working load: 220 N (45 lbf)

## Installation Notes

Install assembly with M4 (No. 6) round head screws (not supplied) or 4 (.156) rivets

## Notes

Order keepers separately, see page 210

## L Link style

- 1 Flat
- 3 Short curved
- 4 Shallow hook
- 5 Deep hook

## F Finish

- 07 Steel, zinc plated
- 13 Black E-coat
- 24 316 Stainless steel electropolished
- 52 300 Stainless steel passivated

TL - 40 - B T L - F

## B Base type

- 1 Exposed
- 2 Concealed

## T Lever type

- 0 Standard
- 1 Secondary catch (Steel & 300 Stainless steel model only) (Exposed base only)
- 2 Padlockable (Steel model only) (Concealed base only)

## Part Number Selection

Latch only

See page 210 for keepers



# TL Keeper Keeper

- Multiple keeper options for application variances
- Suitable for all TL-20 and TL-40 latches

### Material and Finish

Stainless steel, steel, zinc plated or steel, black E-coat

### Installation Notes

Install assembly with M4 (No. 6) round head screws (not supplied) or 4 (.156) rivets

### Exposed

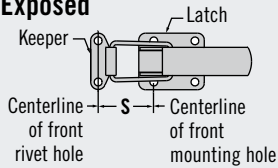

### Concealed

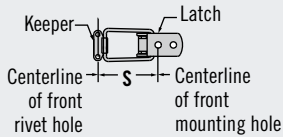

### Part Number Selection

1. Select your latch choice in the draw latch column
2. Select your keeper style in the keeper style row
3. Where the column and row meet use the figure for your install S dimension

### Small

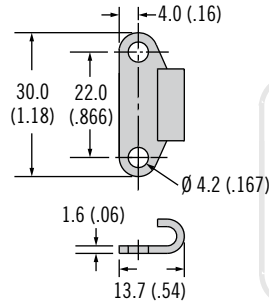

### Narrow

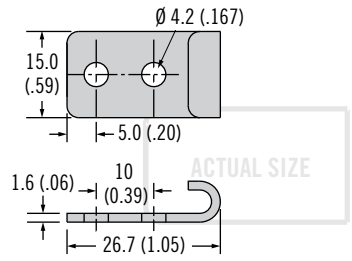

### Right Angle

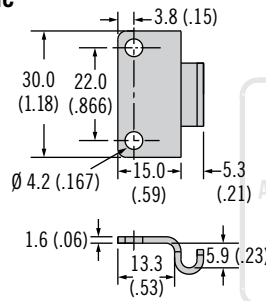

### Large

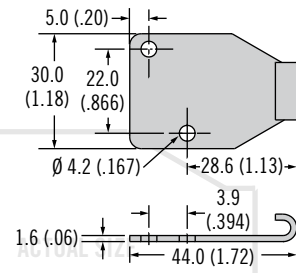

### Medium

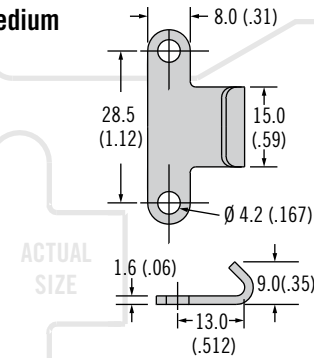

Contact Southco for assistance in determining the "S" dimension.

- B** Base type
- 1 Small
  - 2 Narrow
  - 3 Right angle
  - 5 Large
  - 9 Medium

- F** Finish
- 07 Steel, zinc plated
  - 13 Black E-coat
  - 24 316 stainless steel electropolished
  - 52 300 stainless steel passivated

TL - 17 - 20 **B** - **F**

Keeper Style	Small	Narrow	Large	Medium
	TL-17-201-F	TL-17-202-F	TL-17-205-F	TL-17-209-F
<b>Draw Latch</b>	<b>S Dimension</b>			
TL-20-101	44.7 (1.76)	46.7 (1.84)	62.0 (2.44)	49.0 (1.93)
TL-20-102	30.3 (1.19)	32.3 (1.27)	47.6 (1.87)	34.6 (1.36)
TL-20-103	44.7 (1.76)	46.7 (1.84)	62.0 (2.44)	49.0 (1.93)
TL-20-106	33.9 (1.33)	35.9 (1.41)	51.2 (2.02)	38.2 (1.50)
TL-20-201	41.7 (1.64)	43.7 (1.72)	59.0 (2.32)	46.0 (1.81)
TL-20-202	28.2 (1.11)	30.2 (1.19)	45.5 (1.79)	32.5 (1.28)
TL-20-203	41.7 (1.64)	43.7 (1.72)	59.0 (2.32)	46.0 (1.81)
TL-40-101	30.7 (1.21)	32.7 (1.29)	48.0 (1.89)	35.0 (1.38)
TL-40-103	30.7 (1.21)	32.7 (1.29)	48.0 (1.89)	35.0 (1.38)
TL-40-201	43.7 (1.72)	45.7 (1.80)	61.0 (2.40)	48.0 (1.89)
TL-40-203	43.7 (1.72)	45.7 (1.80)	61.0 (2.40)	48.0 (1.89)

Dimensions in millimeters (inch) unless otherwise stated

# TL Draw Latch

Over-center · Large · Wire bail

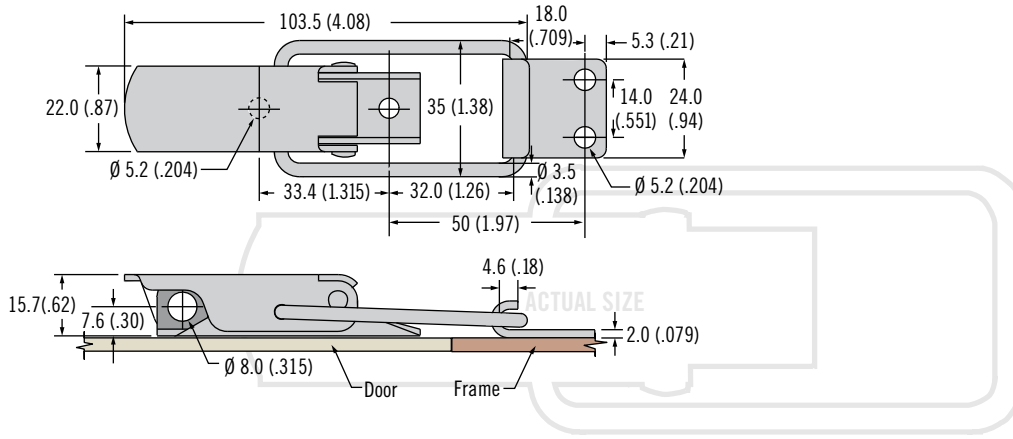

Description	Part Number	
	Steel	Stainless Steel
Latch	TL-50-201-07	TL-50-201-52
Keeper	TL-17-501-07	TL-17-501-52

## • Robust construction

### Material and Finish

Stainless steel or steel, zinc plated

### Performance Details

Working load: 2490 N (560 lbf)

### Installation Notes

Install assembly with M5 (No. 10) round head screws (not supplied) or 5 (.196) rivets.

### Part Number

See table

Order latch and keeper separately

Other options available. For complete details on variety, part numbers, installation and specification, go to



[www.southco.com/TL](http://www.southco.com/TL)

# TL Draw Latch

Over-center · Heavy-duty · Wire bail

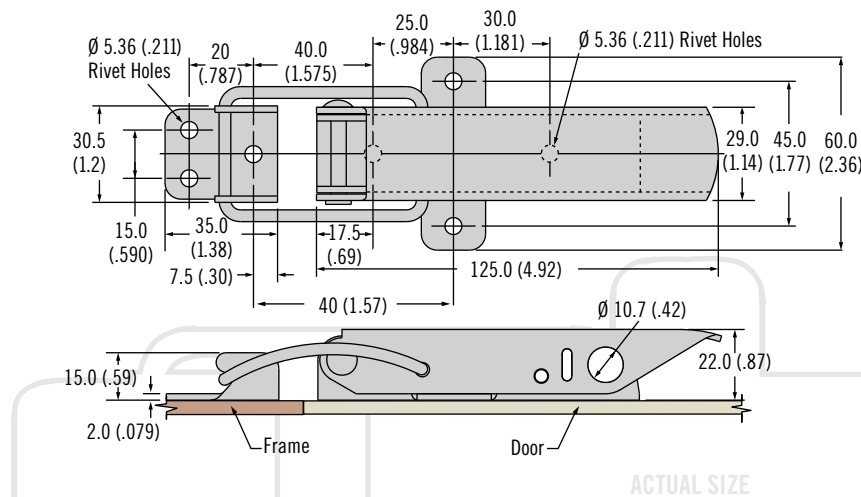

Description	Part Number
Draw Latch	TL-60-102-07
Keeper	TL-17-601-07

## • Robust construction

### Material and Finish

Steel, zinc plated

### Performance Details

Working load: 2670 N (600 lbf)

### Installation Notes

Install assembly with M5 (No. 10) round head screws (not supplied) or 5 (.196) rivets

### Part Number

See table

Order latch and keeper separately

Other options available. For complete details on variety, part numbers, installation and specification, go to



[www.southco.com/TL](http://www.southco.com/TL)

# TL Slide Latch

Steel · Slide to close

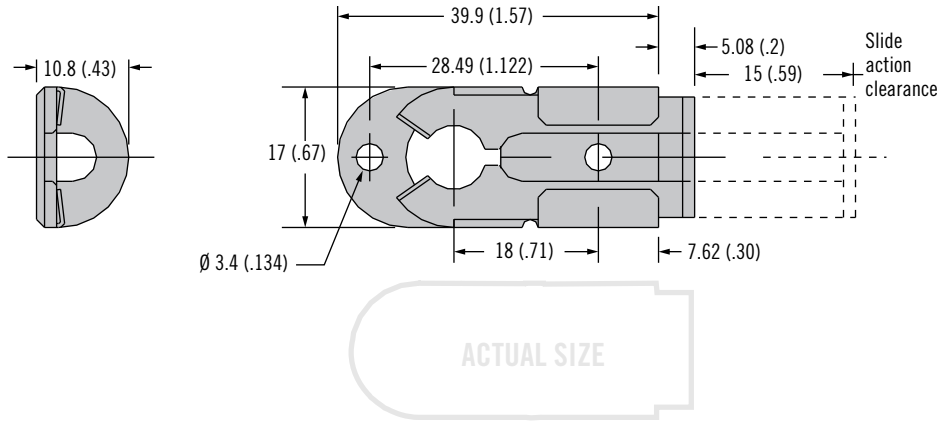

- Slide to secure
- Vibration dampening

### Material and Finish

Steel, zinc plated

### Surface Mount

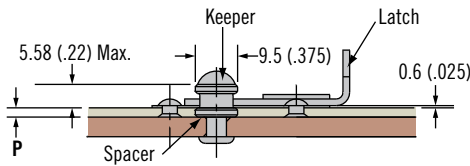

### Concealed Mount

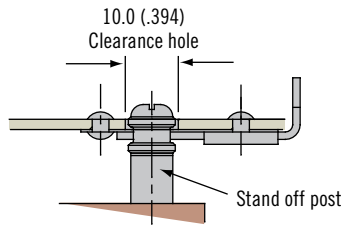

Panel Thickness	Required Number of Spacers
1.17 - 2.03 (.046 - .080)	None
2.05 - 3.25 (.081 - .128)	One
3.28 - 4.06 (.129 - .160)	Two

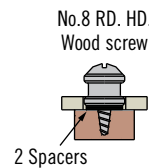
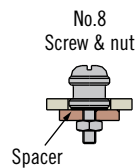
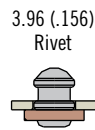

Inside diameter of keeper and spacer: 4.4 (0.17)

Material	Latch		Keeper	Spacer
	Surface Mount	Concealed Mount		
Steel, zinc plated	TL-05-100-07	TL-05-110-07	TL-05-117-07	TL-05-114-07
Stainless Steel	TL-05-100-52	TL-05-110-52	TL-05-117-52	~

### Part Number

See table