

# ACCESS HARDWARE

## MT Snappy Push-to-Close Panel Latch

B



The Snappy is a simple, efficient slam latch for hatches. It offers a built-in self-correcting feature that keeps the latch functioning properly, even if the deadbolt is forced out of its normal position.

- All non-corrosive material
- Over-centre latching for vibration resistance
- Self adjusting pawl misalignment

### Option:

Available in white or brown nylon

	Imperial		Metric
	Nominal	Decimal	
A	1 25/64	1.38	35
B	11/32	0.35	9
C	5/32	0.17	4
D	1 7/64	1.09	28
E	1 15/32	1.47	37
F	5/16	0.94	24
G	1/8	0.14	3.5
H	1 3/16	1.18	30
I	25/32	0.78	20
J	47/64	0.75	19
K	11/32	0.34	8.6
L	25/32	0.77	19.5
M	35/64	0.54	13.7

Colour	Part Number
White	MT-01-10-7
Brown	MT-01-10-3

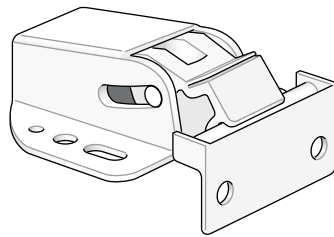

### Catch

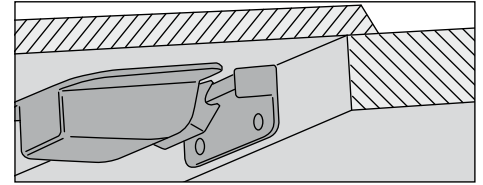
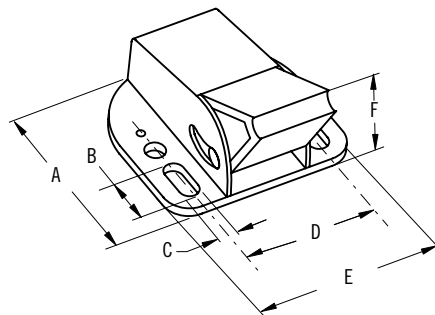

### Keeper

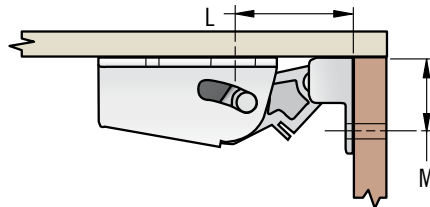
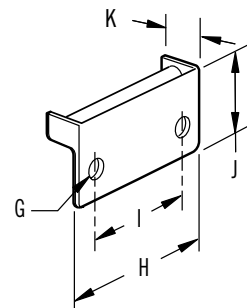

### Operation

*Closed*

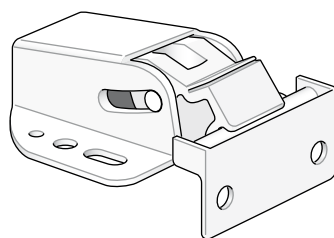

*Open*

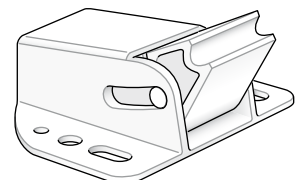

MT-01-10-7  
MT-02-10-1  
MT-02-10-2  
MT-02-10-5  
MT-03-10-5  
MT-03-11-5  
MT-03-12-5  
MT-03-13-5  
MT-03-20-5  
MT-03-21-5  
MT-03-23-5  
MT-04-11-24  
MT-05-330-3  
MT-05-330-6  
MT-05-330-7  
MT-05-480-6  
MT-06-330-6  
MT-06-330-7  
MT-06-480-6  
MT-06-480-7  
MT-07-330-6  
MT-07-330-7  
MT-99-13  
MT-R0535