



**ONURFIX®**

# C 08

Welding Gun

92-20-256



# Operating Manual

**Customer Service in Germany:**

**HBS Bolzenschweiss-Systeme GmbH & Co. KG**  
**Felix-Wankel-Strasse 18**  
**85221 Dachau / Germany**

**Phone +49 (0) 8131 511-0**  
**Fax +49 (0) 8131 511-100**  
**E-mail [post@hbs-info.com](mailto:post@hbs-info.com)**  
**Web [www.hbs-info.com](http://www.hbs-info.com)**

---

**C 08 Operating Manual, Issue 03/2008 Order No. BA 92-20-256**

---

**Copyright:**

The information contained herein may not be copied, reproduced, adapted, merged, translated or used without the prior written consent of the copyright owner.

Adaptations, errors and technical modifications reserved without prior notice.

© HBS Bolzenschweiss-Systeme GmbH & Co. KG

Dear customer,

Thank you very much for purchasing a welding gun from HBS Bolzenschweiss-Systeme.

We from HBS wish you always successful working with this stud welding unit.

We ask you to observe the following points:

- Store the operating manual in a way that it can always be accessed by the operator.
- Let the operator sign before starting up that he has read and completely understood the operating manual.
- This operating manual applies only to this stud welding unit.
- Protect the stud welding unit from unauthorized use.
- The stud welding unit must only be operated by trained personnel.
- Let an electrician check whether the wall sockets where you want to connect the related stud welding unit, are properly fused and grounded.
- Inform our customer service in case of malfunction.
- In case of accident, inform a physician and the responsible official body.



#### **THREAT TO LIFE!**

**Persons fitted with a pace maker must not operate the stud welding machine.**



#### **MAGNETIC FIELDS!**

**During stud welding, strong electro-magnetic fields are generated. Do not weld in the vicinity of the electrical equipment which could be affected.**

Safety instructions are a delicate subject. Anybody who handles a stud welding unit, whether it is the welding gun or the power unit, should be familiar with them, because improper use of stud welding units can be dangerous to life.

For your own sake you should know the safety instructions for operating your HBS stud welding units inside out.

In addition to the protection of your health and the capital value of the enterprise, the safety instructions are intended to clarify any responsibilities, which arise from ownership and operation of the equipment.

This chapter of the operating manual offers you clear and easy to understand information for the safe operation of your HBS stud welding unit.

---

Your welding gun may differ in some details from the captions in this manual. This has no effect on the operation of the welding gun.

Should you have questions about this manual or in case you want to order some more copies, please provide the order number listed in the foot line.

Important reminder:

Data and information herein were collected with greatest care. Although we did our very best to correctly update any information up to the time of delivery, there is no guarantee in respect of errors.

If you should detect errors or mistakes right in this manual, please contact us:

HBS Bolzenschweiss-Systeme GmbH & Co. KG

Felix-Wankel-Strasse 18

85221 Dachau / Germany

A feedback blank is provided in the appendix.

## Table of Contents

<b>1</b>	<b>General .....</b>	<b>7</b>
1.1	Guide to this Operating Manual .....	8
1.2	Safety Symbols .....	9
1.3	General Safety Instructions .....	10
1.4	Intended Use .....	10
1.5	Transportation, Packaging, Storage .....	11
1.6	Accompanying Documents .....	11
1.7	Markings .....	12
<b>2</b>	<b>Delivery .....</b>	<b>13</b>
<b>3</b>	<b>Starting-up .....</b>	<b>14</b>
3.1	Requirements of Workplace .....	14
3.2	Connecting the Welding Gun to the Power Unit .....	15
3.3	Ground Connection .....	16
3.4	Change Working Place .....	17
<b>4</b>	<b>Function .....</b>	<b>18</b>
4.1	Components of the Welding Gun .....	18
4.2	Adjustment of Chuck .....	19
4.3	Installation of Chuck .....	20
4.4	Adjustment of Spring Force .....	21
<b>5</b>	<b>Stud Welding Procedure .....</b>	<b>22</b>
5.1	Safety Instructions .....	22
5.2	Functional Principle of Stud Welding .....	25
5.2.1	Contact Stud Welding .....	25
5.3	Welding Preparation .....	26
5.4	High-strength Welds .....	26
5.5	Determination of Welding Parameters .....	26
5.6	Welding Procedure .....	28
5.7	Checking the Quality of the Weld .....	29
5.7.1	Visual Inspection .....	29
5.7.2	Bending Test .....	30
5.7.3	Arc Blow Effect .....	32

---

5.8	Malfunctions and Corrective Actions .....	33
5.9	Welding Elements .....	34
<b>6</b>	<b>Switching off the Welding Gun .....</b>	<b>36</b>
6.1	Temporary Switching off .....	36
6.2	Disposal .....	36
<b>7</b>	<b>Care and Maintenance .....</b>	<b>37</b>
7.1	Safety Instructions .....	37
7.2	Regular Maintenance Operations .....	38
<b>8</b>	<b>Appendix .....</b>	<b>39</b>
8.1	Technical Data .....	39
8.2	Spare Parts .....	40
8.3	Accessories .....	42
8.4	Environmentally Admissible Disposal .....	48
	<b>Glossary .....</b>	<b>49</b>
	<b>Regulations and Standards .....</b>	<b>50</b>
	<b>Further Instructions .....</b>	<b>52</b>
	<b>Guarantee Clauses .....</b>	<b>53</b>
	<b>EU-Statement of Conformity .....</b>	<b>54</b>
	<b>Confirmation .....</b>	<b>55</b>
	<b>Feedback .....</b>	<b>56</b>
	<b>Service &amp; Support .....</b>	<b>57</b>
	<b>Index .....</b>	<b>58</b>

## 1 General

### Persons addressed by this operating manual

This operating manual is written for operators, personnel of the end user, and authorized service technicians. It provides you with all necessary information to operate the welding gun.

### Required user qualification

The welding gun must only be operated by qualified personnel.

- ◆ Let the welding gun only be operated by persons who
  - are qualified through a suitable training according to the current standards (see appendix),
  - are properly instructed,
  - are physically and intellectually suitable,
  - can be expected to reliably fulfill the requested job.

### What else must the owner observe?

- ◆ Make sure that this operating manual is always in reach of the stud welding unit.
- ◆ Read the entire manual before operating the welding gun.
- ◆ Strictly observe the safety instructions.
- ◆ Before starting up the welding gun, let the operator sign the confirmation that he/she has read and fully understood the operating manual (see appendix).
- ◆ Do not commence stud welding until you have understood all operating processes.
- ◆ Contact us if there are any doubts on certain operating procedures.
- ◆ Protect the power unit against unauthorized use.
- ◆ Inform our service in case of malfunction.

Based on this operating manual, a company specific work order, as well as a company specific maintenance instruction must be drawn up. The company specific work order must consider the special user conditions in your company.

Make sure that operators of the welder are provided with and wear personal protective equipment, e.g. protective goggles, gloves, shoes, ear protection etc.

Owners and operators make sure that the welding gun is only used as directed.

- ◆ During any activity such as transportation, set-up, (re-)assembly, production, maintenance etc. observe the information given in this operating manual.

## 1.1 Guide to this Operating Manual

This operating manual provides you with the following information

“Delivery“	in Chapter 2
“Starting-up“	in Chapter 3
“Functional Principle“	in Chapter 4
“Stud Welding Process“	in Chapter 5
“Switching off the Welding Gun“	in Chapter 6
“Care and Maintenance“	in Chapter 7
Technical Data and much more	in the Appendix

**THREAT TO LIFE and risk of serious health and material damage in case of improper use of the welding gun. Observe all notes in this operating manual.**



**Note for qualified operators (see chapter 1).**



**All instructions contained in this manual must also be observed by qualified operators.**

**The welding process and the sequence of procedures to carry out a weld are described in chapter 5.**



## 1.2 Safety Symbols

Symbols and markings used in this operating manual mean:



Threat to life or risk of personal injury



Risk of material damage



Ban for persons fitted with a pace maker



Warning of dangerous electrical voltage



Warning of electromagnetic fields



Wear protective clothes



Wear protective goggles



Wear ear protection



Additional tips for operation and service safety



Prompt



List

### 1.3 General Safety Instructions



**Improper operation of the stud welding unit is LIFE-THREATENING!**

**Threat to life**

- by electric shock and arc
- by toxic vapours and airborne particles
- by red-hot metal spatters (fire risk)
- by blow-up of explosive gases and materials
- by strong magnetic fields for persons fitted with a pace maker

In addition, through improper use damage to the stud welding unit and to material can be caused. For details, see chapters 1, 3 and 5.

### 1.4 Intended Use



**Danger**

**Warning: Unauthorized interference with the stud welding unit as well as unauthorized alteration of the stud welding unit are prohibited and result in complete cancellation of any guarantee and liability claims against HBS.**



**Operation of welding gun is only allowed with HBS power units, this clause is also part of “use as directed“.**

The welding gun is intended to weld welding elements according to actual standards (see chapter 5 and appendix). Any other use is regarded as not used as directed. The manufacturer is not liable for damages resulting from the stud welding unit not used as directed. Any risk is carried by the user.

The welding gun is designed according to specific standards and accident prevention regulations. Basics are European Union guidelines and in Germany valid standards. *Please note that in your country additional standards and safety conditions (especially rules for accident prevention) may differ from the standards mentioned in this operating manual.* The welding gun was manufactured to the latest developments in technology and is regarded as safe to operate (place of operation see section 8.1).

The welding gun C 08 can be connected to the HBS power units CD 1501, CD 2301, CD 3101, CDM 1601, CDM 2401 and CDM 3201. For details please contact the HBS customer service (address see page ii).

- ◆ Check in any case the operating manual of the HBS power unit whether this welding gun can be used.

Observing the operating manual of the used power unit is also part of the „use as directed“.

## 1.5 Transportation, Packaging, Storage

HBS delivers products in a specific transport package.

- ◆ Save the undamaged packing. Ship and transport the device only in its original packing.

Right before delivery, the welding gun is once again checked for proper functioning and a control mark is attached. When receiving the delivery, check everything for damages and completeness. If damages occurred during transportation or components are missing, inform the manufacturer or the haulier immediately (see page ii).

Proper functioning of the welding gun can only be checked before starting-up by visual inspection (visible damage).

The following items are to be observed if the welding gun is not to be put into operation immediately after delivery.

- The welding gun must be stored in a secure place
- The welding gun must be protected against humidity, dust, metallic dirt.
  - Storage temperature: -5 °C to +50 °C
  - Relative humidity: 0% to 50% at +40 °C  
0% to 90% at +20 °C
- ◆ If you resell the welding gun, please provide us with the name and postal address of the new owner so that we can advise them of any changes to the operating manual.

## 1.6 Accompanying Documents

In addition to this operating manual, you must observe the operating manual of the power unit as well as applicable accident prevention and safety instructions.

## 1.7 Markings

There are various markings and safety symbols attached to your power unit (see section 8.1).

- ◆ Make sure that all markings remain clearly visible.

### Type plate

The type plate contains the following data:

Manufacturer

Type

Order No./Serial No.

Primary voltage

Fuse

Power consumption

Cooling class

Protection class

Date

### Safety symbols



**Replace illegible or damaged markings**



**Before opening machine disconnect mains**



**Observe operating manual**



**Warning of dangerous electrical voltage**

- ◆ Secure the following safety symbols in the area of welding place:



## 2 Delivery

The basic equipment of your welding gun contains the following components:

No. of pieces	Part	Type	Order No.
1	Gun cable length 6.5 m	C 08	92-20-256
1	Operating manual	C 08	BA 92-20-256

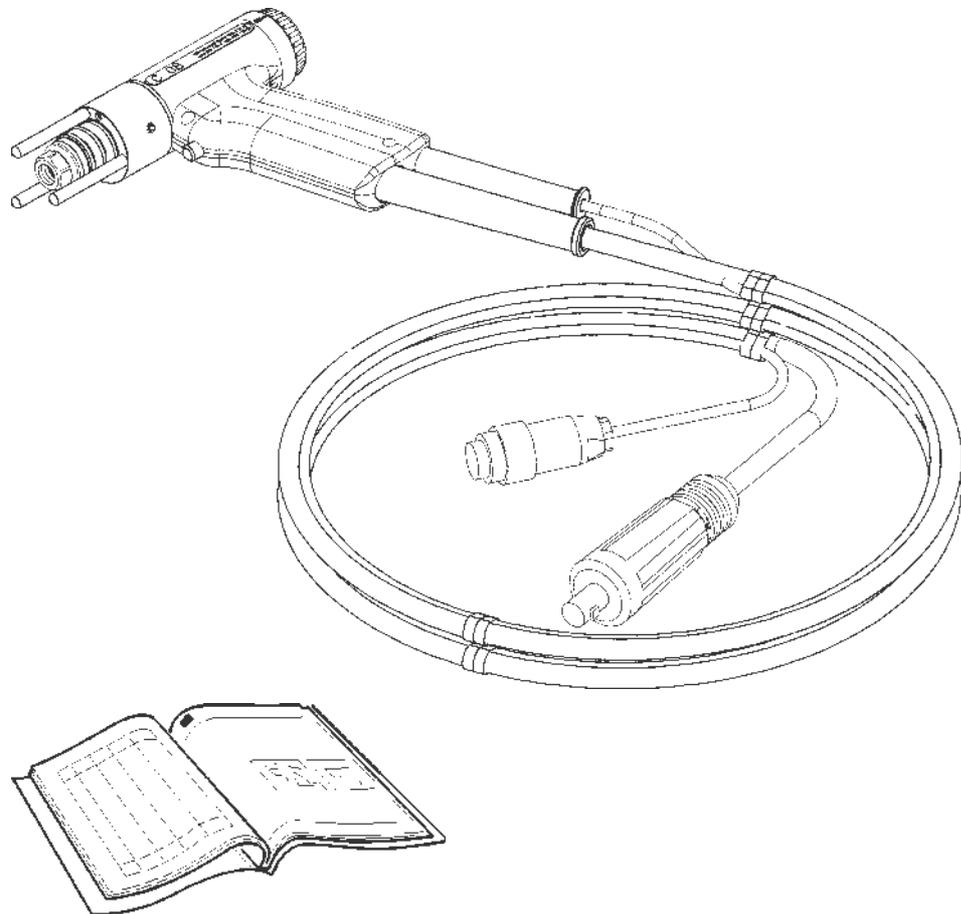

### 3 Starting-up

In this chapter you learn what to observe during setting-up and starting-up of the welding gun.

#### 3.1 Requirements of Workplace



**The welding gun protection is to class IP 20. Do not use the welding gun in humid environment!**



**Vapors and airborne particles may occur during stud welding operations. Especially with surface treated materials, toxic vapors may be produced.**

- ◆ Ensure that a fume extraction is available and that the room is adequately ventilated according to accident prevention regulations.
- ◆ If possible, do not weld in rooms which are lower than 3 meters.
- ◆ Special regulations apply for confined rooms, according to accident prevention regulations of the official bodies (see appendix).
- ◆ Weld only in adequate distance from combustible articles or liquids.
- ◆ Before you start welding, remove any combustible articles or liquids in vicinity of the workplace.
- ◆ Make sure that a fire extinguisher is within reach.
- ◆ Never weld in rooms exposed to risk of explosion.
- ◆ Do not set-up the product in the vicinity of any apparatus or equipment which is sensitive to welding spatters.
- ◆ Do not set-up the product in the vicinity of any apparatus or equipment which is sensitive to magnetic fields.
- ◆ Set-up the welding gun:
  - on a stable, clean and level surface
  - so that no-one is influenced or injured by welding spatters
  - so that all cables and primary lines are protected from being damaged
  - so that nobody will trip or fall over the cables or connection lines.
- ◆ Ensure that air is able to circulate freely through the housing.



**If heat is built-up inside the housing caused by bad air circulation, the stud welding unit will be seriously damaged.**

- ◆ Secure the following safety symbols in the area of welding place:



### THREAT TO LIFE to persons fitted with a pace maker

Strong electro-magnetic fields occur in the vicinity of the stud welding unit during welding. Such fields may affect the proper function of a pace maker. Thus persons equipped with a pace maker must not operate the stud welding unit and must not stay in its vicinity during welding.



During the actual welding process, you must expect red-hot welding spatters, possibly liquid spatters, a flash, and a loud bang > 90 dB (A). Alert any colleagues who are occupied in the vicinity of the welder.

Wear your personal protective equipment according to actual standards (see appendix).

## 3.2 Connecting the Welding Gun to the Power Unit



**Switch off the power unit. In this way, you avoid any risk of electrical shock.**

- ◆ Plug the welding cable of the welding gun into the socket of the power unit.
- ◆ Press-in the plug and twist firmly clockwise.

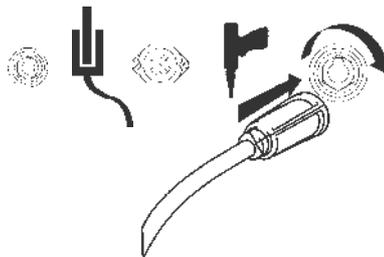

Danger

**The connection is not secured against working itself loose! Check the plug connections regularly to ensure that they are properly locked. In case of loose connection, heat may build up in the plug and may destroy the entire plug connection.**

- ◆ Plug the control cable of the welding gun into the appropriate connection of the power unit.

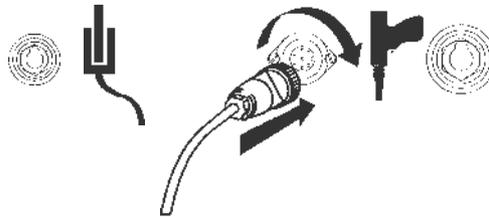

- ◆ Twist the retaining nut of the control cable connector clockwise to secure the connection.



**The welding gun cables must not be coiled during welding. Coiled cables work as a coil and may negatively affect the welding result. Before welding, lay out the cables lengthwise.**

- ◆ Fix the cables. Strong magnetic fields occur during welding which may cause a movement of the cables. This may cause a slackness of the connections.

### 3.3 Ground Connection

- ◆ Plug the ground cable in the connector of the power unit.

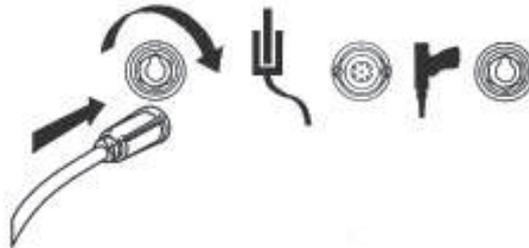

- ◆ Press in the plug and twist firmly clockwise.



**The connection is not secured against working itself loose! Check the plug connections regularly to ensure that they are properly locked. In case of loose connection, heat may build up in the plug and may destroy the entire plug connection.**

- ◆ Remove any rust, paint, or contaminants from the workpiece in the areas where you intend to connect the ground cables.



- ◆ Connect the ground clamps to the workpiece as securely as possible.

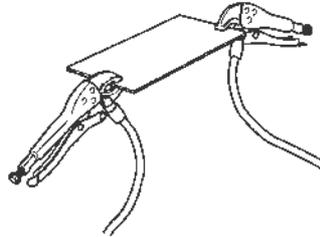

Take care to ensure good contact and symmetrical connection. The welding location must lie directly between the two ground clamps.

### 3.4 Change Working Place



**Switch off the power unit. In this way, you avoid any risk of electrical shock.**

- ◆ When you move your workplace, disconnect the welding gun and the ground cables from the power unit. Proceed in reversed sequence as described in section 3.2 and 3.3.
- ◆ After changing the workplace, check the welding gun and the ground cables for possible damage or missing components.

## 4 Function

In this chapter you learn more about the design of the welding gun and how to use the various setting options.

### 4.1 Components of the Welding Gun

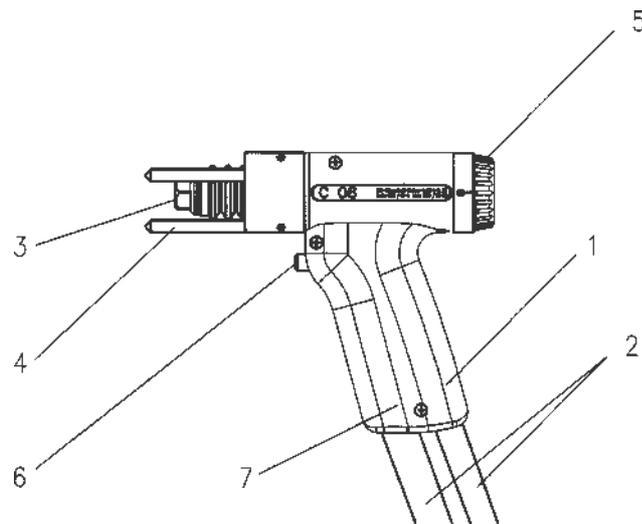

The body of the welding gun consists of a sturdy two-part **plastic housing** (1).

The **control cable** and the **welding cable** (2) are connected through the welding gun handle to the welding gun.

Positioned at the front of the welding gun are the welding piston and the **retaining nut** (3) used to fix the manual chuck.

At the front of the welding gun, the foot ring is installed. Three **legs** (4) can be used to position the welding gun straight.

At the rear, there is the mechanism for **spring force adjustment** (5).

At the front of the welding gun handle, the **welding gun trigger** (6) is installed. It is used to trigger the welding process.

The **serial number** (7) can be found on the welding gun handle.

## 4.2 Adjustment of Chuck

Various chucks for different stud diameters are available as unit accessories (see appendix).

- ◆ Select the chuck which fits the diameter of your welding element.
- ◆ Put the welding element into the chuck. In the chuck, there is an adjustable stop pin.
- ◆ Loosen the retaining nut.
- ◆ Twist the stop pin in the chuck in a way that
  - the unthreaded part of the pin is inside the chuck (for welding elements up to 20 mm length),

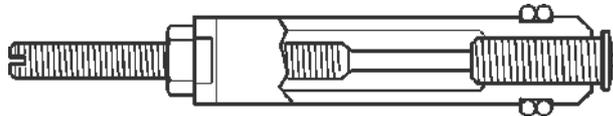

- the unthreaded part of the pin projects is out of the welding element (for welding elements above 20 mm length).

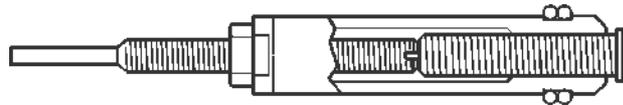

**As special accessory, a stop pin for welding elements with internal thread is available.**

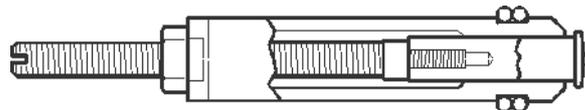

- ◆ Adjust the standard stop pin in such a way that an overall distance of 50 mm is obtained between upper face of the retaining nut and bottom of the welding element.

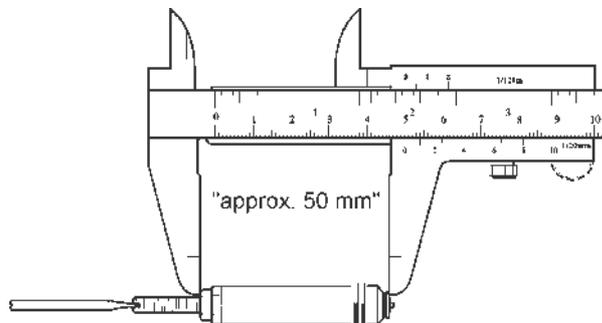

- ◆ Retighten the retaining nut.

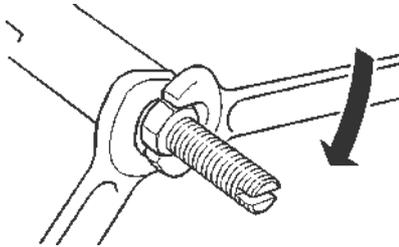

Retighten regularly and carefully the chuck at the four segments (see figure below, at the visible end of the chuck) using pliers to ensure a proper current transition. This will prevent early wear through spark erosion.

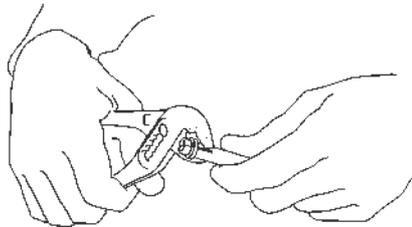

### 4.3 Installation of Chuck

- ◆ Put the chuck with loose retaining nut up to the stop into the piston of the welding gun.

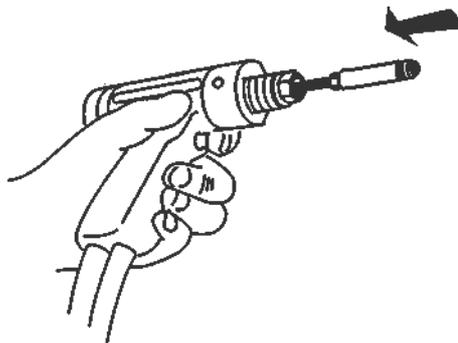

- ◆ Tighten the retaining nut with the socket wrench SW 17.

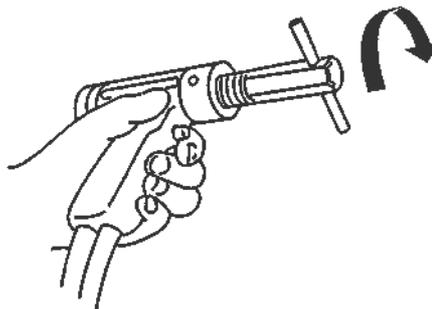

#### 4.4 Adjustment of Spring Force

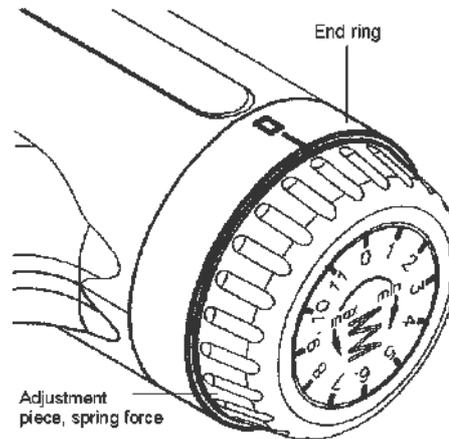

**The adjustment piece spring force can be turned by max. 360°. Forced turning with noticeable resistance of the adjustment piece spring force can result in mechanical damage of components.**

- ◆ Twist the adjustment piece spring force clockwise, until the 'min' position is reached.
- ◆ Now twist the end ring until its '0' marking lines up with the '0' marking of the adjustment piece spring force.
- ◆ Now rotate the adjustment piece spring force to the selected reference value (table in chapter 5) to determine the spring pre-tensioning.
- ◆ Depending on your welding job, you may change the spring tension.



**Calibration of the adjustment piece spring force has no reference to any measurement unit.**

- ◆ Turning the adjustment piece spring force clockwise decreases the spring pre-tensioning of the welding piston.
- ◆ Turning the adjustment piece spring force anti-clockwise increases the spring pre-tensioning of the welding piston.

## 5 Stud Welding Procedure

This chapter contains the basics of stud welding, how you must actually proceed, and what must be observed. You learn to select correct welding parameters and which welding elements can be used.

### 5.1 Safety Instructions



**Improper operation of the power unit is LIFE-THREATENING!**

**Threat to life**

- by electric shock and arc
- by toxic vapors and airborne particles
- by red-hot metal spatters (fire risk)
- by blow-up of explosive gases and materials
- during welding of hollow parts
- by strong magnetic fields to persons fitted with a pace maker



**THREAT TO LIFE by electrical shock and arc**

During the actual stud welding process, do not touch the welding elements, chuck, or retaining nut nor any electrically conductive parts in their vicinity. These are all electrically life.

Step onto an insulating mat, if you have to weld under the following conditions:

- in confined rooms with electrically conductive walls
- under confined conditions between or on electrically conductive parts
- with restricted freedom of movement on electrically conductive parts
- in wet or hot areas

When operating the stud welding unit, you must not wear any metallic jewellery incl. wrist watches, especially on hands. Remove any electrically conductive or electro-magnetically sensitive parts from your body before you start welding. In this way, you avoid the risk of damage by electric shock or influence of electromagnetic fields.



### **THREAT TO LIFE by toxic vapors and airborne particles**

Toxic vapors and airborne particles may occur during stud welding operations, especially with surface treated materials.

Ensure that a fume extraction is available that the room is adequately ventilated according to accident prevention regulations.

If possible, do not weld in rooms which are lower than 3 meters. Special regulations apply for confined rooms according to accident prevention regulations of the official bodies of your country (see appendix).



### **THREAT TO LIFE by red-hot metal spatters (fire risk)**

Make sure that a fire extinguisher is within reach.

Do not wear clothes, which are contaminated with combustible materials like oil, grease, kerosene etc. during welding.

Always wear your personal protective equipment such as:

- protective gloves to current standards (see appendix),
- safety goggles with a window providing protection class 2 to current standards (see appendix),
- non-combustible clothes
- ear protection to current standards (see appendix),
- a protective apron over your clothes,
- a protective headgear when welding overhead.

Before starting to weld, remove all combustible articles and liquids in vicinity of the workplace.

Weld only in sufficient distance from combustible articles or liquids. choose a safety distance where there is no risk to injury from welding spatters!



### **THREAT TO LIFE by blow-up of explosive gases and materials**

Never weld in rooms exposed to danger by explosion.

Special know-how is required when welding hollow parts which

- are combustible or support combustion,
- can emit toxic gases, vapors, or airborne particles,
- can explode.

Never execute such operations, if you do not have such special know-how.



Observe the regulations for accident prevention and standards which apply to the use of your stud welding unit (see appendix). The official Professional Association of your country will provide you with further information.

*Please note that in your country additional standards and safety conditions (especially rules for accident prevention) may differ from the standards mentioned in this operating manual.*

**THREAT TO LIFE to persons fitted with a pace maker**

Strong electro-magnetic fields occur in the vicinity of the stud welding unit during welding. Such fields may affect the proper function of a pace maker. Thus persons equipped with a pace maker must not operate the stud welding unit and must not stay in its vicinity during welding.



During the actual welding process, you must expect red-hot welding spatters, possibly liquid spatters, a flash, and a loud bang > 90 dB (A). Alert any colleagues who are occupied in the vicinity of the welder.

Wear your personal protective equipment according to actual standards (see appendix).

**MAGNETIC FIELDS!**

During stud welding, strong magnetic fields are present. Do not weld in the vicinity of electrical systems and machines which could be affected.

**Danger**

**Warning: Unauthorized interference with the stud welding unit as well as unauthorized alteration of the stud welding unit are prohibited and result in complete cancellation of any guarantee and liability claims against HBS.**

- ◆ In case of any accidents whatsoever, advise a physician, your supervisor, and the official bodies immediately.



## 5.2 Functional Principle of Stud Welding

Stud welding with tip ignition is divided into gap stud welding and contact stud welding.

### 5.2.1 Contact Stud Welding

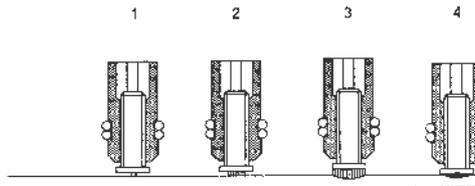

- The welding gun is placed onto the workpiece (figure 5.2.1, position 1). The welding element which projects above the welding gun support legs, is pushed back tensioning a pressure spring.
- After positioning the welding gun against the workpiece, the operator triggers the welding gun button and starts the welding process; thus the current circuit is closed.
- The capacitors of the power unit are discharged. Because of the high discharge current, the ignition tip evaporates explosion-like. The air gap between welding element and workpiece is ionized (see figure 5.2.1, position 2), an arc is produced.
- The arc melts the face of the welding element together with an area of the workpiece of about the same dimension (see figure 5.2.1, position 3).
- Caused by the pressure spring, the welding element moves to the workpiece with a speed of 0,5 to 1 m/s. The adjusted spring force controls the plunging speed of the welding element.
- Higher plunging speed leads to shortened arc time and consequently to lower welding energy with identical voltage setting.
- The arc is cut as soon as the welding element touches the workpiece.
- Now the capacitors are short-circuited and the rest of the energy drains off (see figure 5.2.1, position 4).
- The pressure spring continues to push the welding element into the weld pool.
- The weld pool solidifies and the welding element is physically connected to the workpiece.
- The time period between ignition of the arc and solidification of the weld pool is about 3 ms.



**With high plunging speed of the welding element, the air gap closes after vaporization of the ignition tip faster, thus the arc time becomes shorter. With rapidly oxidizing materials like e.g. aluminum, the arc must only burn a very short time.**

- The use of contact welding for rapidly oxidizing materials like aluminum and aluminum alloys is not recommended because the arcing period with contact welding is longer than with gap stud welding.

### 5.3 Welding Preparation

- ◆ Read the safety instructions in chapters 1, 3 and 5.
- ◆ Observe the workplace requirements (chapter 3, "Starting-up").
- ◆ Check all cables and connections for proper condition.
- ◆ Replace immediately defective cables and cable connections to avoid electrical shocks.
- ◆ Check the chuck for proper seat (see operating manual of according power unit).
- ◆ Before welding, make sure that the bellows are checked for damage and proper seat.

### 5.4 High-strength Welds

- ◆ The following must be removed both from the weld zone and the ground clamp connection areas:
  - paint, oil and any other impurities,
  - rust,
  - non-conductive coatings from surface treated workpieces.
- ◆ Weld to smooth and flat surfaces only.



**For welding to pipes or punched plates consult our responsible application manager (address of customer service see page ii).**

### 5.5 Determination of Welding Parameters

The adjustment of welding parameters on the power unit (e.g. charging voltage via energy controller) or on the welding gun (e.g. spring force) depends amongst others on

- material of the welding element
- diameter of the welding element
- material of the workpiece

The guidelines should be verified by test welding on the actual material and be changed if necessary. For an assessment of welding results, see section 5.7 and 5.8.

**Example:**  
**welding parameters for welding gun C 08 in connection with power unit CD 1501**



Data given in the following table are only guidelines. They must be verified by trial welds on the actual material according to actual standards and DVS guidelines (see appendix). Before you use another lot of welding elements, carry out some trial welds to verify the parameter setting.

Material of welding elements	Diameter of welding elements (metric)		Diameter of welding elements (imperial)		Energy		Gun parameters C 08 Spring force (scaling)
	PT, UT	IT			CD 1500 Adjustment (scaling)	CD 1501 Charging voltage (V)	
Material of workpiece: Mild steel, shiny S235 / St37.3k (4.8) weldable							
S235 / St37 (4.8)	M3, 3 mm	--	1/8"	#6-32	3	70	6
S235 / St37 (4.8)	M4, 4 mm	--	5/32"	#8-32	4	90	6
S235 / St37 (4.8)	M5, 5 mm	5 mm, M3	3/16"	#10-32	5	120	6
S235 / St37 (4.8)	M6, 6 mm	6 mm, M4	1/4"	1/4-20	6	140	6
S235 / St37 (4.8)	M8, 7,1 mm	7,1 mm, M5	5/16"	5/16-18	8	190	6
S235 / St37 (4.8)	M10, --	7,1 mm, M5	3/8"	3/8-16"	1)	1)	6
Material of workpiece: Steel galvanized S235							
S235	M3, 3 mm	--	1/8"	#6-32	4	90	6
S235	M4, 4 mm	--	5/32"	#8-32	5	120	6
S235	M5, 5 mm	--	3/16"	#10-32	7	160	6
S235	M6, 6 mm	--	1/4"	1/4-20	9	200	6
Material of workpiece: Cr-Ni stainless steel 1.4301, 1.4303							
1.4301, 1.4303	M3, 3 mm	--	1/8"	#6-32	2	60	6
1.4301, 1.4303	M4, 4 mm	--	5/32"	#8-32	3	70	6
1.4301, 1.4303	M5, 5 mm	--	3/16"	#10-32	4,5	100	6
1.4301, 1.4303	M6, 6 mm	--	1/4"	1/4-20	6	140	6
1.4301, 1.4303	M8, 7,1 mm	--	5/16"	5/16-18	8	190	6
Material of workpiece: Brass CuZn37							
CuZn37	M3, 3 mm	--	1/8"	#6-32	2	60	6
CuZn37	M4, 4 mm	--	5/32"	#8-32	3,5	80	6
CuZn37	M5, 5 mm	--	3/16"	#10-32	5	120	9
CuZn37	M6, 6 mm	--	1/4"	1/4-20	6,5	150	9
Material of workpiece: Aluminum							
AlMg3	M3, 3 mm	--	1/8"	#6-32	2)	2)	2)
AlMg3	M4, 4 mm	--	5/32"	#8-32	2)	2)	2)
AlMg3	M5, 5 mm	--	3/16"	#10-32	2)	2)	2)
AlMg3	M6, 6 mm	--	1/4"	1/4-20	2)	2)	2)

1) power unit with higher capacity recommended

2) not possible. For a safe aluminum weld we recommend welding gun CA 08.



**Further notes on**  
 - welding elements  
 - prestress at installation (tie load) and torque  
 - material combinations  
 see appendix and operating manual of the according power unit.

## 5.6 Welding Procedure



**Improper operation of the stud welding unit is LIFE-THREATENING! The stud welding unit must only be operated by qualified personnel (see chapter 1). Observe the safety instructions in chapters 1, 3 and 5.**

- ◆ Prepare the stud welding unit, the ground connection and the workpiece according to the instructions given in the operating manual.



**Chapter 5 contains guideline for welding parameters. The data given are only guidelines. They must be verified by trial welds on the actual workpiece according to actual standards and DVS regulations (see appendix).**



**During the actual welding process, you must expect red-hot welding spatters, possibly liquid spatters, a flash, and a loud bang may occur > 90dB (A). Inform any colleagues who are occupied in the vicinity of the welder about the bang.**

**Wear always your personal protective equipment according to actual standards (see appendix).**

- ◆ Insert the welding element into the chuck.

As soon as the power unit is ready for the welding process,

- ◆ place the welding gun vertically against the workpiece,
- ◆ push the welding gun firmly with both hands onto the workpiece until the welding gun support (distance device) is evenly seated on the workpiece,
- ◆ hold the welding gun firmly, still, and straight,
- ◆ take care that you do not touch any metallic part of the welding gun,
- ◆ press the trigger button of the welding gun.

This initiates the welding process.



**The welding process can only be initiated, if the current circuit is closed, i.e. the welding element is in electrical contact with the base material.**



**After the welding process has been completed, withdraw the welding gun straight back from the welding element. If you remove the welding gun at an angle, the chuck will be stretched, this reduces its life expectancy.**

You can now insert a new welding element in the chuck and repeat the welding process as described above.

## 5.7 Checking the Quality of the Weld

You can check the quality of the weld by means of a visual inspection and a bending test.



See also actual standards in the appendix “Arc stud welding of metallic materials“, in section irregularities and corrective actions

### 5.7.1 Visual Inspection

A visual inspection must be carried out with each welding element.

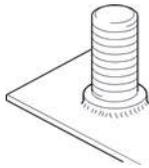
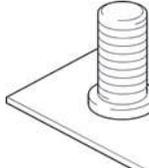
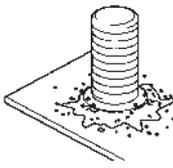
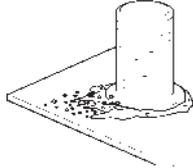
Visual Inspection		
Condition	Possible cause	Corrective actions
Good welded joint Low spatters around the weld without outer flaws The weld pool forms a collar around the flange of about 1 - 1,5 mm 	<ul style="list-style-type: none"> <li>- Correct parameters</li> </ul>	<ul style="list-style-type: none"> <li>- None</li> </ul>
Cold weld pool Gap between flange and workpiece 	<ul style="list-style-type: none"> <li>- Heat input too low</li> <li>- Plunging speed too low</li> <li>- No sufficient backing of workpiece</li> </ul>	<ul style="list-style-type: none"> <li>- Increase charging voltage</li> <li>- Adjust plunging speed correctly</li> <li>- Provide sufficient backing</li> </ul>
Hot weld pool Many spatters around the weld 	<ul style="list-style-type: none"> <li>- Heat input too high</li> <li>- Plunging speed too low</li> </ul>	<ul style="list-style-type: none"> <li>- Reduce charging voltage</li> <li>- Increase plunging speed</li> </ul>
One-sided weld pool One-sided spatter collar Weld pool came out on one side 	<ul style="list-style-type: none"> <li>- Arc blow effect</li> <li>- Unsymmetric ground connection</li> <li>- Welding gun put at an angle</li> </ul>	<ul style="list-style-type: none"> <li>- Take care for symmetrical ground connection</li> <li>- Put welding gun vertically to the workpiece</li> </ul>

### 5.7.2 Bending Test

You can purchase from HBS a bending device with inserts for various diameters of the welding elements.

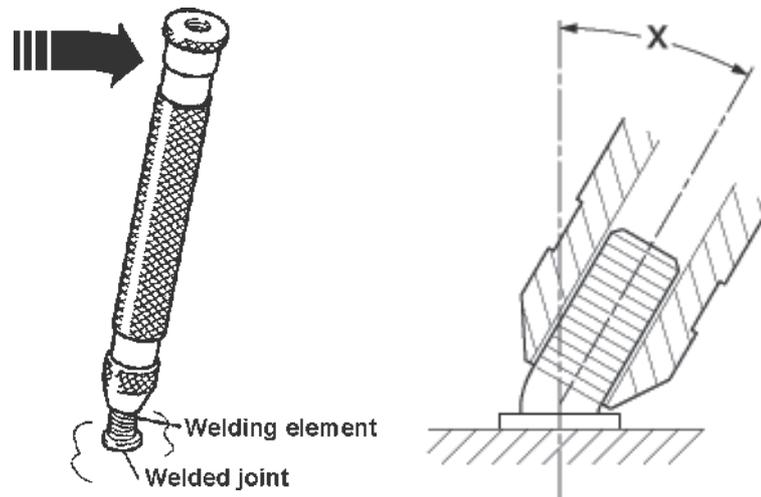

The bending test serves as an easy work sample and as a check for the selected welding parameters. The welded joint is stressed by bending in a non-defined way.

- ◆ Bend the welding element with the bending device once by 30°.

Carry out the test in different directions.

The bending test is passed if a crack or a fracture of the welded zone does not occur.

- ◆ Please note the instructions on malfunctions and corrective actions in chapter 5.



**You don't need to test all studs. It is sufficient to carry out stud tests at random.**

If the strength of the joint is inadequate, then:

- ◆ check the setting of the stud welding unit
- ◆ check whether the surface of welding element and base material are clean and electrically conductive (must be free from scale, oil, paint, oxide layers)
- ◆ grind off hardened workpiece surfaces (e.g. roll hardening).
- ◆ Check the piston of the welding gun for ease of movement.

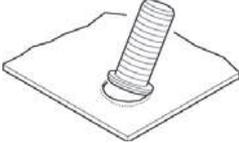
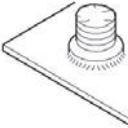
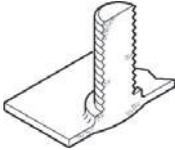
Bending Test		
Type of fracture	Possible cause	Corrective actions
Base material buckling 	- Correct parameters	- none
Fracture in the welding element above flange 	- Correct parameters	- none
Fracture in the weld metal 	<ul style="list-style-type: none"> <li>- Heat input too low</li> <li>- Plunging speed too low</li> <li>- Welding element/base material combination not suitable</li> </ul>	<ul style="list-style-type: none"> <li>- Increase charging voltage</li> <li>- Increase plunging speed</li> <li>- Replace welding element or workpiece</li> </ul>
Backside deformation 	<ul style="list-style-type: none"> <li>- Heat input too high</li> <li>- Pressure too high</li> <li>- Contact stud welding not suitable</li> <li>- Workpiece too thin</li> </ul>	<ul style="list-style-type: none"> <li>- Reduce charging voltage</li> <li>- Reduce pressure</li> <li>- Use gap stud welding instead of contact stud welding</li> <li>- Adapt thickness of workpiece</li> </ul>

### 5.7.3 Arc Blow Effect

A so called arc blow effect can occur with unproportionally distributed ground connections in relation to the base material mass, varying material distribution, or welding at the edge of a workpiece. This is an undesired deflection of the arc. It causes a single-sided melting of the stud material, increased pore formation, and undercuts in the welding area.

The arc blow effect is proportional to the current and can be influenced by symmetric installation of the ground clamps, by fitting of compensation masses, or by rotating the welding gun around its vertical axis (applies for welding guns with external welding cable).

#### Arc blow effects and some corrective actions

(according to standards, see appendix)

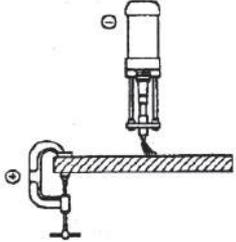
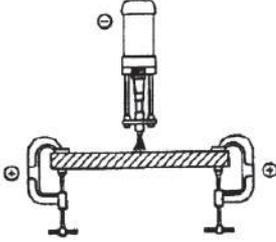
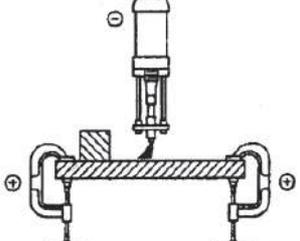
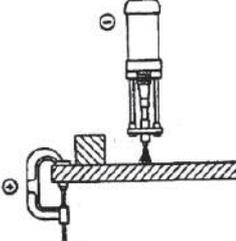
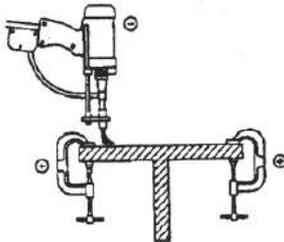
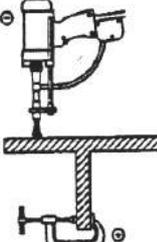
Cause	Corrective action
	
	
	



## 5.8 Malfunctions and Corrective Actions

Malfunction	Possible cause	Fault finding	Corrective action	Carried out by
Welding elements not firmly attached	Wrong welding parameters selected	Check charging voltage on power unit	Change adjusted parameters	Instructed personnel
		Check spring force of welding gun	Change adjusted parameters	Instructed personnel
	Plunging speed of welding element too low	Check welding piston and linear bearing that they are smooth running *)	Clean or replace *)	Qualified personnel
Scorchings at welded element	Chuck is worn	Check chuck for possible wear	Replace chuck	Instructed personnel
	Lamellas of chuck are not pre-tensioned	O-rings existing? Check o-rings for wear and fracture	Replace o-rings	Instructed personnel
Welding gun does not weld	Control cable defective (with present contact signal on power unit)	Check control cable for electrical flow at socket (Pin 3 and 4) of the control cable socket with pressed welding gun trigger *)	In case of no flow : Replace control cable *)	Qualified personnel
		Trigger switch defective (with present contact signal on power unit)	Check trigger switch for electrical flow with pressed welding gun *)	In case of no flow : Replace micro switch *)
	Welding cable defective (no contact signal on power unit)	Check, whether welding cable is connected to power unit	Connect welding cable	Instructed personnel
		Check welding cable for electrical flow *)	In case of no flow : Replace welding cable and/or connection cable *)	Qualified personnel
	Ground connection defective (no contact signal on power unit)	Check, whether ground cable is connected to workpiece	Connect ground cable	Instructed personnel
Check ground cable for electrical flow		In case of no flow : Replace ground cable	Instructed personnel	
Power unit defective	Follow the instructions of the connected power unit	Repair required	Factory service or authorized agencies	



**Actions marked with \*) must only be carried out by qualified electricians!**



**Danger**

**If none of the actions is successful, please contact our service department.**

## 5.9 Welding Elements

The stud welding unit must be suitable for welding the welding elements to be used. Observe the instructions in the operating manuals.

Welding elements manufactured with the cold formed process have a flange and an ignition tip (see actual standards in the appendix). During welding, the flange prevents the arc getting to the cylindrical part of the welding element and increases simultaneously the welding area.

We recommend the following standard welding elements (see appendix).

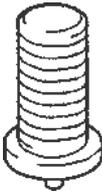

**Use only welding elements of the same lot. Take particular care not to mix-up different lots. Slightest variations in geometry of the welding elements, especially of the ignition tip, require modified settings of the welding process.**

Threaded stud PT *	Diameter	Length	Stud
	M3	6-30 mm	82-50-003
	M4	6-40 mm	82-50-004
	M5	8-45 mm	82-50-005
	M6	8-55 mm	82-50-006
	M8	10-55 mm	82-50-008

Materials: S235 / St37.3k (4.8) / 1.4301, 1.4303 / CuZn37 / AlMg3

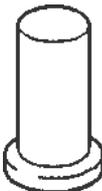
Pin UT *	Diameter	Length	Stud
	3 mm	6-25 mm	82-50-003
	4 mm	6-25 mm	82-50-004
	5 mm	6-40 mm	82-50-005
	6 mm	8-50 mm	82-50-006
	7,1 mm	10-55 mm	82-50-071

Materials: S235 / St37.3k (4.8) / 1.4301, 1.4303 / CuZn37 / AlMg3

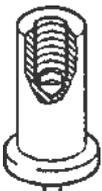
Pin with internal thread IT * (Internal thread sleeve)	Diameter	Length	Stud	Internal thread
	5 mm	6-30 mm	82-50-905	M3
	6 mm	8-30 mm	82-50-906	M3
	6 mm	8-30 mm	82-50-906	M4
	7,1 mm	10-30 mm	82-50-971	M5
	8 mm	10-40 mm	82-50-908	M6

Materials: S235 / St37.3k (4.8) / 1.4301, 1.4303 / CuZn37 / AlMg3

\* from 40 mm length upwards only weldable with distance ring up to 55 mm, order-no. 92-40-010.

Flat connection

Dimensions

Stud



6,3

82-50-050

Materials: S235 / St37.3k (4,8) / 1.4301, 1.4303 / CuZn37 / AlMg3

ISO-nails\*\*

Diameter

Length

Stud



2

20-100 mm

82-50-020

3

30-250 mm

82-50-030

Materials: S235 / St37.3k (4,8) / 1.4301, 1.4303

ISO-clips

for nails

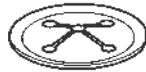

Ø 2

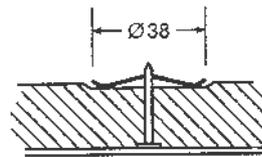

Ø 3

Materials: St2k70 galvanized / 1.4301, 1.4303

ISO-clips  
plastic coated

for nails



Ø 3

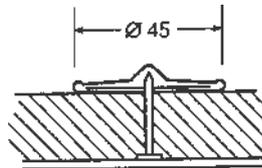

Material: St2k70 galvanized

We look forward to consult you with view to special welding elements and other special materials.

HBS Bolzenschweiss-Systeme GmbH & Co. KG

Felix-Wankel-Strasse 18

85221 Dachau / Germany

Phone +49 (0) 8131 511-0

Fax +49 (0) 8131 511-100

E-mail [post@hbs-info.com](mailto:post@hbs-info.com)

\*\* above 100 mm length, only weldable with tripod order no. 92-40-043.

## **6 Switching off the Welding Gun**

This chapter describes what you should observe when you switch off the welding gun temporarily or completely.

### **6.1 Temporary Switching off**

- ◆ Switch off the power unit.
- ◆ Unplug the control cable and the welding cable from the welding gun.
- ◆ Protect the welding gun against ingress of fluids and foreign bodies.

### **6.2 Disposal**

If you shut down the installation, you can return the complete welding gun to HBS (for address see page ii).

We will take care of environmentally correct material separation and disposal.

## 7 Care and Maintenance

This chapter shows care and maintenance of the welding gun to provide long life expectancy.

### 7.1 Safety Instructions



Let maintenance and repair operations be carried out only by qualified personnel or by your competent service technician.



Before you start any cleaning and maintenance operation with welding gun, switch off the connected power unit and disconnect control cable and welding cable from power unit.

## 7.2 Regular Maintenance Operations



**Any maintenance and repair operation should only be carried out by qualified personnel or by your competent service technician.**

**You must only carry out the following service operations.**

- ◆ Before starting welding, check welding cable and control cable for faults and damage.



**Threat to life!**  
**Never work with damaged cables. Use of damaged cables means risking an electrical shock.**



**Before you start any cleaning and maintenance operation with welding gun, switch off the connected power unit and disconnect control cable and welding cable from power unit.**

- ◆ Clean the surface of the welding gun of dirt and dust.



**Danger**

**Do not use any solvent containing cleaning agents. Solvent containing cleaning agents may damage the plastic components of the welding gun.**

- ◆ Check the chuck from time to time. If you disclose scorching areas on the chuck, replace the chuck (see chapter 4 and 5).
- ◆ Before you start working, check the bellows at the front end of the welding gun for possible damage and if properly installed.



**Danger**

**Never work with damaged or improperly installed bellows. This may significantly affect life expectancy of your welding gun.**

There are some markings (type and adjustment guides) placed at the welding gun.

- ◆ Take care that markings remain clearly visible.
- ◆ Replace illegible or damaged markings.

## 8 Appendix

In the appendix, there is information of interest regarding technical data, spare part lists, accessories, standards, etc.

### 8.1 Technical Data

#### **Welding Gun Type C 08 for CD stud welding according to current standards**

Welding range	M3 to M8, dia. 2 to 8 mm (#4 to 5/16", dia. 14 ga to 5/16") other dimensions on request
Stud length	6 to 40 mm (0.24" to 1.57"), longer studs can be welded with optional accessories
Stud material	Mild steel, stainless steel
Stud type	Any type or shape (special chucks if required)
Spring pressure	Adjustable, arresting
Welding cable	6.5 m (21.33')
Protection class	IP 20 (protect against humidity)
Workplace noise level	> 90 dB (A) may occur during welding
Operational and storage conditions	According to current standards
Dimension L x W x H	170 x 40 x 140 mm (6.70" x 1.57" x 5.51") (without cable)
Weight	0.5 kg (1.10 lbs) (without cable)

## 8.2 Spare Parts

### Spare part list welding gun type C 08 (92-20-256)

When ordering spare parts, please indicate order number and type of welding gun.

Pos.	Quantity	Order No.	Description
1	1	88-10-673B	Basic shell, complete
3	1	80-09-045	Cover shell
5	3	80-11-270	Screw EJOT A30x8
6	2	80-11-271	Screw EJOT A30x12
7	1	80-50-014	Micro switch
9	2	80-90-102	Screw M2 x 10
11	1	80-09-029	Trigger complete
13	1	80-08-380A	Cable clamp
21	1	80-09-843B	Piston contact, complete
31	1	80-09-765	Pressure spring , contact
35	1	80-09-022	Axial arrest
37	1	88-10-678A	Adjustment piece spring force complete
39	1	80-11-272	Sticker spring force
41	1	88-10-879	End ring
49	1	80-70-139	Connecting line, complete
51	1	80-10-019	Antikink bushing
53	11	80-10-021	Cable clamp
55	1	80-50-059	Cable connector
57	1	80-50-013	Control cable connector
63	1	80-09-021B	Connection cable
65	1	80-90-153	Nut M 4
67	3	80-90-164	Washer 4 mm
69	1	80-90-108	Screw M4 x 12
70	1	80-90-110	Screw M4 x 8
75	2	80-11-476	Sticker
79	1	80-20-013	Bellows
81	1	80-40-040	Retaining nut
83	1	80-10-027	O-ring
87	1	80-40-373	Foot ring
89	3	80-90-144	Screw M5 x 4
91	3	80-40-049	Foot



Welding gun type C 08 (92-20-256)

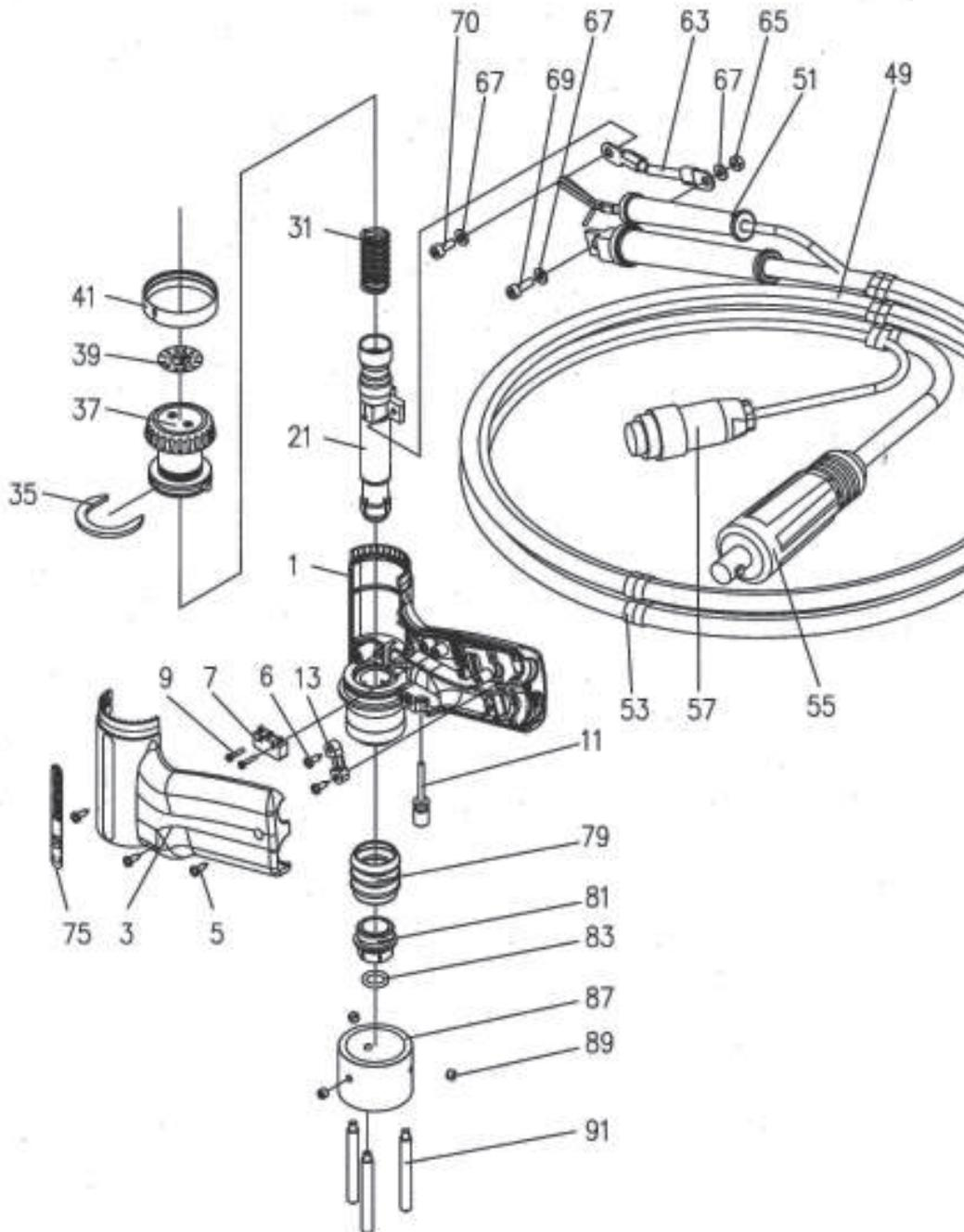

### 8.3 Accessories

When ordering accessories, please indicate order number and type of welding gun.

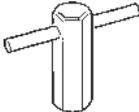
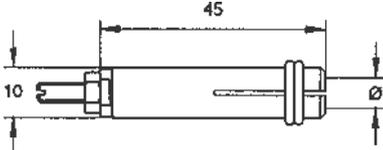
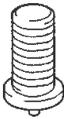
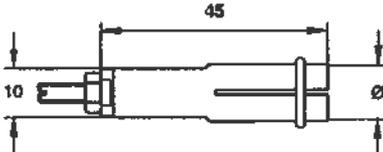
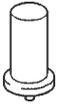
for	Description	Order No.
	<b>Socket wrench</b>	80-40-085
		
	<b>Chuck</b>	
		
Threaded stud PT	M2	82-50-002
	M2,5	82-50-025
	M3	82-50-003
	M4	82-50-004
	M5	82-50-005
	M6	82-50-006
	M8	82-50-008
		
	M10	82-50-009
Pin UT	Ø 3 mm	82-50-003
	Ø 4 mm	82-50-004
	Ø 5 mm	82-50-005
	Ø 6 mm	82-50-006
	Ø 7.1 mm	82-50-071
Bushes with internal thread IT	Ø 5 mm	82-50-905
	Ø 6 mm	82-50-906
	Ø 7,1 mm	82-50-971

for	Description	Order No.
-----	-------------	-----------

**Chuck**

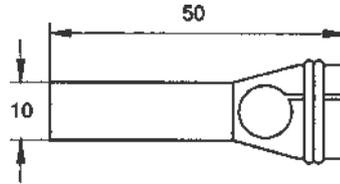

Flat pin +  
Double flat pin

6.3 mm

82-50-050

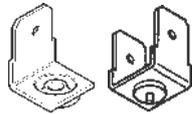

**Chuck**

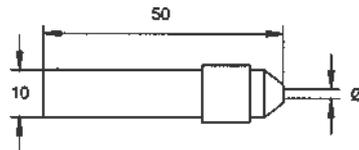

ISO-nail

Ø 2 mm  
Ø 3 mm

82-50-020  
82-50-030



Welding of welding  
elements up to 8.5 mm  
minimum distance

**Angle PWA**

82-40-011

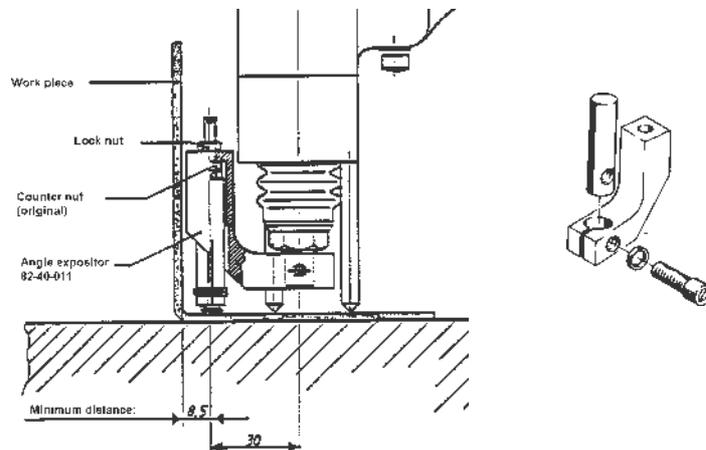

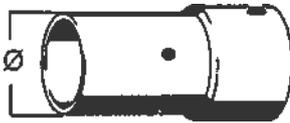
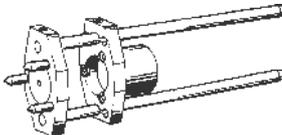
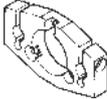
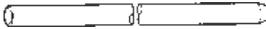
for	Description	Order No.
Simplified working	<b>Positioning tube PPR2</b>  Ø 30 mm	80-40-513
Noise damping or protect against dropping welding spatters	<b>Noise damping tube PSR2</b>  Ø 35 mm	82-40-016
ISO nails 100 to 300 mm length welding elements from 40 mm length	<b>Tripod with 3-point rest PSI2</b> 	92-40-043
PSI2	<b>3-point foot piece</b> 	80-40-127
PSI2	<b>Foot</b> 	80-40-306
PSI2	<b>Clamping plate</b> 	80-40-126
PSI2	<b>Tripod pillar</b>  70 mm length 220 mm length	80-40-129 80-40-130

for	Description	Order No.
-----	-------------	-----------

Accurate positioning  
in welding templates

**Centering device complete PZV2  
with cylinder pin, centering pot  
and chuck extension**



Ø 20 mm	92-40-111
Ø 26 mm	92-40-117
Ø 30 mm	92-40-119

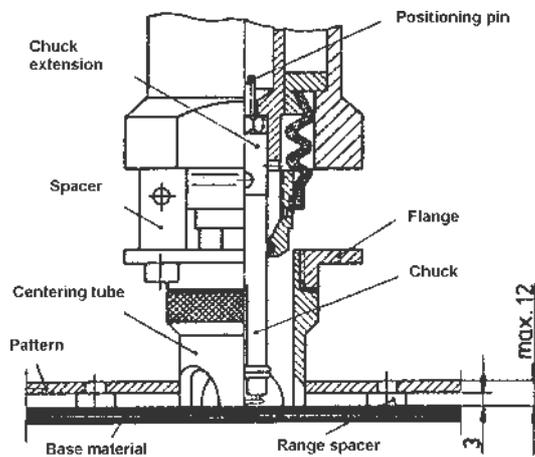

PZV2

**Centering tube**



Ø 20 mm	80-40-082
Ø 26 mm	80-40-086
Ø 30 mm	80-40-083

PZV2

**Centering pot (to adjust)**



Ø 20 mm	80-40-092
Ø 26 mm	80-40-096
Ø 30 mm	80-40-093

PZV2

**Pin 10 x 70 (to adjust)**

80-10-092



PZV2

**Chuck extension**

80-40-081



for	Description	Order No.
Welding elements 40 to 56 mm length	<b>Distance ring 16 mm</b> 	92-40-010
Foot ring	<b>Foot</b>  Ø 6 mm Ø 6 mm with hard tip	80-40-049 80-40-076
Pitch circle Ø diameter 38 mm	<b>Foot ring TK38</b> 	80-40-521
TK38	<b>Foot</b> 	80-40-077

for	Description	Order No.
Bending test according to actual standards (see appendix)	<p><b>Bending device complete BBV</b> including equipment to eject uptight studs, including a set of bushings for 3 - 8 mm</p> 	92-40-042
	<p><b>Bending device</b> including equipment to eject uptight studs, without bushings</p> 	80-40-120
	<p><b>Bushing for bending device</b></p> 	
	for welding elements M3	80-40-121
	for welding elements M4	80-40-122
	for welding elements M5	80-40-123
	for welding elements M6	80-40-124
	for welding elements M8	80-40-125
Center punching	<p><b>Automated punch ATK</b> (Constant punch size)</p> 	80-10-353

---

## 8.4 Environmentally Admissible Disposal

- ◆ After repair of the welding gun, dispose replaced parts in an environmentally admissible way.

Used materials:

- Steel
- Nonferrous metals (brass, copper)
- Plastics
- Aluminum



## Glossary

Arc:	Electrical discharge at its own between two electrodes under sufficiently high current. Whitish light is emitted. The arc generates very high temperatures.
Automatic welding head:	Device to weld welding elements
Capacitor:	A component which serves as storage of electrical charge
Power unit:	Device to provide electrical energy for stud welding
Rectifier:	Electric component transforming alternating current into direct current
Stud feeder:	Device for the automatic stud feeding of welding elements
Stud welding unit:	Power unit inclusive welding gun
Thyristor:	Electronic component, contactless switch, which will let the current only pass through if a control pulse is given to the gate (additional electrode)
Welding element:	A component, like a stud, bolt, pin, which is welded to the work piece
Welding gun:	Device to weld welding elements
Welding parameters:	Various settings on the gun as well as on the power unit. For example: duration and strength of current during welding process, charging voltage, spring force of the welding gun.
Work piece:	A component, like a sheet, tube, etc. to which the welding element is fastened

## Regulations and Standards

The regulations and standards are recommendations and don't purport to be completely.

<b>Standards, regulations</b>	<b>Description</b>
<u>Stud welding (fundamentals)</u>	
DIN EN ISO 13918	Welding - Studs and ceramic ferrules for arc stud welding
DIN EN ISO 14555	Welding - Arc stud welding of metallic materials
DIN EN 1418	Welding personnel - Approval testing of welding operators for fusion welding and resistance weld setters for fully mechanized and automatic welding of metallic materials
DVS 0901	Stud welding method for metals - General
DVS 0902	Drawn-arc stud welding
DVS 0903	Capacitor-discharge stud welding with tip ignition
DVS 0904	Instructions for practice - Arc stud welding
DVS 2927	Resistor projection welding and Arc welding of one-sided thick plastics coated thin metal sheets
<u>Stud welding (general)</u>	
DIN EN ISO 4063	Welding and allied processes - Nomenclature of processes and reference numbers
DIN ISO 857-1	Welding and allied processes - Vocabulary - Part 1: Metal welding processes
DIN EN ISO 14175	Welding consumables - Gases and gas mixtures for fusion welding and allied processes
DIN EN 764-1	Pressure equipment - Part 1: Terminology - Pressure, temperature, volume, nominal size
DIN EN ISO 6947	Welds - Working positions - Definitions of angles of slope and rotation

Machine safety

2006/95/EC	Electrical equipment designed for use within certain voltage limits
2004/108/EC	EMC-Guidelines
98/37/EC	Machine guideline (valid until 28.12.2009)
2006/42/EC	Machine guideline (valid from 29.12.2009)
DIN EN 60204-1	Safety of machinery - Electrical equipment of machines - Part 1: General requirements
DIN EN 60529	Degrees of protection provided by enclosures (IP code)
DIN EN 60974-1	Arc welding equipment - Part 1: Welding power sources
DIN EN 60974-10	Arc welding equipment - Part 10: Electromagnetic compatibility (EMC) requirements

Personal safety and accident prevention

DIN EN ISO 20345	Personal protective equipment - Safety footwear
DIN EN 12477	Protective gloves for welders
DIN EN 166	Personal eye-protection - Specifications
DIN EN 352-1	Hearing protectors - General requirements - Part 1: Ear-Muffs
BGV A1	Accident-prevention regulation „Principles of prevention“
BGV A3	Accident-prevention regulation „Electrical equipment and operating material“
BGV A8	Accident-prevention regulation „Health and safety signs at work“
BGV B11	Safety rules “EMC”
BGV D1	Safety rules - welding, cutting and similar processes



**Please note that in your country additional standards and safety conditions (especially rules for accident prevention) may differ from the standards mentioned in this operating manual.**

## Further Instructions

### Welding elements, abbreviations, materials, standards, mechanical properties to actual standards

Stud types		Abbreviations for studs	Material	Material international name	Norm	Mechanical characteristics
Stud welding with capacitor discharge (TS)	Threaded stud	PT	Steel (S235) 4.8 <sup>1)</sup> copper plated	Mild steel	ISO 898-1	See ISO 898-1
	Fin (Unthreaded stud)	UT	1.4301/03 (A2-50)	Stainless steel AISI 304/305	ISO 3506-1	ISO 3506-1
	Stud with internal thread	IT	CuZn37 (Ms63)	Brass	EN 12166	$R_m \geq 370 \text{ N/mm}^2$
			EN AW-Al99,5	Aluminum 99,5	EN 573-3	$R_m \geq 100 \text{ N/mm}^2$
			EN AW-AlMg3	Aluminum AlMg3	EN 12301-2	$R_m \geq 230 \text{ N/mm}^2$

Further materials on request

<sup>1)</sup> weldable

### Prestress at installation (tie load) and torque

Threaded stud	Steel (S235) 4.8 <sup>1)</sup> $\mu = 0,18$ $R_{p0,2} = 340 \text{ N/mm}^2$		1.4301/03 (A2-50) $\mu = 0,18$ $R_{p0,2} = 210 \text{ N/mm}^2$		AlMg3 (F23) $\mu = 0,18$ $R_{p0,2} = 170 \text{ N/mm}^2$		CuZn37 (Ms63) $\mu = 0,18$ $R_{p0,2} = 250 \text{ N/mm}^2$	
	Prestress at installation (kN)	Torque (Nm)	Prestress at installation (kN)	Torque (Nm)	Prestress at installation (kN)	Torque (Nm)	Prestress at installation (kN)	Torque (Nm)
M3	1,1	0,8	0,7	0,5	0,5	0,4	0,8	0,6
M4	1,8	1,8	1,1	1,1	1,0	0,9	1,4	1,3
M5	3,0	3,6	1,9	2,3	1,6	1,9	2,3	2,7
M6	4,3	6,1	2,7	3,8	2,2	3,1	3,2	4,5
M8	8,0	15,0	4,9	9,5	4,0	7,5	6,0	11,0
M10	13,0	30,0	7,8	19,0				

Values correspond with actual standards

<sup>1)</sup> weldable

All given values are leads for minimum tensile strength and minimum torque of a weld without permanent deformation of parts to be joined. Parts to be joined must have sufficient wall thickness. Values apply for cold rolled threaded studs with standard thread without surface protection and without thread lubrication. Throughout the entire stud length, at least the stressed cross section must be present. Values apply for indicated yield strengths.

### Material combinations

according to the actual standards (select stud material in a way that material of the same kind is welded).

Stud material	Base material				
	ISO/TR 15608 Groups 1 - 6, 11.1	ISO/TR 15608 Groups 1 - 6, 11.1 and galvanized and metal plated steel sheets, max. coating thickness 25 $\mu\text{m}$	ISO/TR 15608 Group 8	Copper and unleaded copper alloys, e.g. CuZn37 (CW508L)	ISO/TR 15608 Groups 21 and 22
Steel (S235) 4.8 <sup>1)</sup>	a	b	a	b	--
1.4301/1.4303	a	b	a	b	--
CuZn37	b	b	b	a	--
EN AW-Al99,5	--	--	--	--	b
EN AW-AlMg3	--	--	--	--	a

Exemplification of welding suitability:  
 -- non weldable  
 a well suited for any application, e.g. power transmission  
 b suitable, limitations with power transmission

Weldability tests of other material combinations upon request.

<sup>1)</sup> weldable

## Guarantee Clauses

Please refer to the current "General Terms and Conditions" for the guarantee clauses.

We are not liable for malfunctions which are caused by

- normal wear,
- improper use,
- non-observing the operating manual,
- transport damages.

Any guarantee claim will be cancelled if repair operations are carried out by unauthorized persons.



**Warning: Unauthorized interference with the stud welding unit as well as unauthorized alteration of the stud welding unit are prohibited and result in complete cancellation of any guarantee and liability claims against HBS.**

Please fill in the serial number:

Serial number automatic welding head: .....

Serial number power unit: .....

Serial number welding gun: .....

Serial number stud feeder: .....

Please indicate the serial numbers in case of enquiries or when ordering spare parts.

## EU-Statement of Conformity

**Manufacturer:** HBS Bolzenschweiss-Systeme GmbH & Co. KG  
Felix-Wankel-Strasse 18  
Postfach 13 46  
85221 Dachau / Germany  
Phone +49 (0) 8131 511-0  
Fax +49 (0) 8131 511-100

**Statement:** This is to certify, that equipment listed below is designed and manufactured in conformance to the safety and health regulations.  
This statement is invalid if any modifications are done on the equipment without prior written approval by HBS.

---

**Description of equipment:** Welding Gun  
**Type:** C 08  
**Order No:** 92-20-256  
**Serial-No:**

---

### Applicable EC-guidelines and corresponding standards:

- **Low voltage guideline 2006/95/EC:**  
DIN EN 60974-1 Arc welding equipment - Part 1: Welding power sources
- **EMC guideline 2004/108/EC:**  
DIN EN 60974-10 Arc welding equipment - Part 10: Electromagnetic compatibility (EMC) requirements
- **Machine guideline 98/37/EC<sup>\*)</sup>:**  
DIN EN 60204-1 Safety of machinery - Electrical equipment of machines - Part 1: General requirements

<sup>\*)</sup> valid until 28.12.2009

- Machine guideline 2006/42/EC, valid from 29.12.2009



---

Date

---

Erwin Promoli (General Manager HBS)







## Service & Support

With the sending please attach a copy of the filled out form together with the repair number given by HBS!  
Repairs without repair number will not be handled.

Repair number  
(given by HBS)

\_\_\_\_\_

Company: \_\_\_\_\_

Name / Surname: \_\_\_\_\_

Street: \_\_\_\_\_

City, State and ZIP: \_\_\_\_\_

Country: \_\_\_\_\_

Phone & Fax: \_\_\_\_\_

E-mail address: \_\_\_\_\_

Unit / gun type of model: \_\_\_\_\_

Serial number: \_\_\_\_\_

Date of purchase: \_\_\_\_\_

Purchased at distributor: \_\_\_\_\_

Further descriptions of default: \_\_\_\_\_

\_\_\_\_\_

\_\_\_\_\_

Service & support may be done up to the value of EUR \_\_\_\_\_ without tender:  Yes  No

Could you find any damage / burning mark:  Yes  No

on the cables:  Yes  No

on chucks:  Yes  No

Are all plug and screw connections fastened tight \*:  Yes  No

Are there any burning marks on plug or screw connections:  Yes  No

Are there any other visual damages (e.g. cracks, dents):  Yes  No

Have you checked the fuses:  Yes  No

Default on the display of the power unit:

ARC					CD						

Which LEDs are burning (please mark with a cross)?

Please e-mail or fax this form to [post@hbs-info.de](mailto:post@hbs-info.de) or fax: ++49 - 81 31 - 5 11 - 1 00.  
In case a repair is necessary you get the required repair number!

- \* See also according operating manual, chapter „Starting-up“
- \*\* Doesn't light when using a contact welding gun

## Index

### A

accessories .....	42
accident prevention .....	10, 23
accident prevention regulations .....	14
accidents .....	24
accompanying documents .....	11
adjustment of chuck .....	19
adjustment piece spring force .....	21, 40
airborne particles .....	14
angle .....	43
appendix .....	39
arc .....	25, 34, 49
arc blow effect .....	29, 32
articles, combustible .....	14
automated punch .....	47
automatic welding head .....	49

### B

bang .....	15, 24, 28
bellows .....	38
bending device complete .....	47
bending test .....	30
blow-up .....	23

### C

cables, defective .....	26
capacitor .....	25, 49
care and maintenance .....	8, 37
centering device complete .....	45
centering tube .....	45
charging voltage .....	26
chuck .....	18, 42
chuck extension .....	45
chuck, installation of .....	20
cleaning agents .....	38
cleaning operations .....	37
company specific work order .....	7
components of the welding gun .....	18
confirmation .....	55
confirmation, operator sign .....	7
contact stud welding .....	25
control cable connector .....	16

### D

delivery .....	8, 13
disposal .....	36, 48
distance device .....	28
distance ring .....	46
DVS regulations .....	28

### E

ear protection .....	7, 23
electrical shock, risk of .....	15, 17
electrical voltage .....	9, 12
electromagnetic fields .....	9
end ring .....	21, 40
energy controller .....	26
entire plug connection, destroying .....	15
EU-Statement of conformity .....	54

### F

feedback .....	56
fire extinguisher .....	14, 23
fire protection on job .....	23
fire risk .....	23
flange .....	34
flash .....	15, 24, 28
flat connection .....	35
fluids, ingress of .....	36
foot .....	46
foot ring .....	46
foreign bodies, ingress of .....	36
fume extraction .....	23
functional principle .....	8, 18
further instructions .....	52

### G

gap stud welding .....	25
general .....	7
general safety instructions .....	10
glossary .....	49
gloves .....	7
ground cable .....	16
ground clamps .....	17
ground connection .....	16
guarantee claims .....	10, 24, 53
guarantee clauses .....	53
guide .....	8

## H

headgear, protective .....	23
heat built-up .....	14
hollow parts, welding on .....	23

## I

ignition tip .....	25, 34
intended use .....	7, 10
internal thread sleeve IT .....	34
ISO-clip .....	35
ISO-nail .....	35
IT, pin with internal thread .....	27, 34, 52

## L

legs .....	18
liability, any .....	10, 24, 53
liquid spatters .....	28
liquids, combustible .....	14
lot .....	34

## M

magnetic fields .....	14, 24
maintenance .....	7
maintenance instruction, company specific .....	7
maintenance operation .....	37
malfunction .....	7
malfunction and corrective actions ...	30, 33
markings .....	12, 38
material combinations .....	27, 52
material of the welding element .....	26
material of the workpiece .....	26
materials, rapidly oxidizing .....	25
metal spatters .....	23

## N

noise damping tube .....	44
non-combustible clothes .....	23

## O

operating manual .....	7, 13
operating manual, storage of .....	7
operation, improper .....	28
operators .....	7
order number .....	40

## P

pace maker .....	9, 15, 24
personnel .....	7
pin UT .....	34
pin with internal thread IT .....	34
pipes, welding to .....	26
place of operation .....	10
plastic housing .....	18
plunging speed .....	21, 25
positioning tube .....	44
power unit .....	10, 49
prestress at installation .....	27, 52
protection class .....	14, 39
protective apron .....	23
protective equipment .....	15, 24
protective equipment, personal .....	7
protective gloves .....	23
protective goggles .....	7
PT, threaded stud .....	27, 34, 52
punched plates, welding to .....	26

## Q

quality of the weld, check the .....	29
--------------------------------------	----

## R

rectifier .....	49
recycling .....	48
regular maintenance operations .....	38
regulations .....	50
repair .....	48
requirements of workplace .....	14
retaining nut .....	16, 19
risk of material damage .....	9
risk of personal injury .....	9
room, adequately ventilated .....	23
room level .....	23
rooms, confined .....	14, 22, 23
rooms, exposed to risk of explosion ...	14

## S

safety instructions .....	7, 22, 37
safety symbols .....	12
safety symbols, means of .....	9
serial number .....	18, 53
service .....	7
service & support .....	57
service technician .....	7

set-up .....	7	welding elements, lot of .....	27
shoes .....	7	welding energy .....	25
spare parts, ordering of .....	40, 53	welding gun .....	10, 49
special welding elements .....	35	welding gun cables .....	16
spring force .....	26	welding gun support .....	28
spring force adjustment .....	18, 21	welding gun trigger .....	18
standards .....	50	welding overhead .....	23
standards, actual .....	10, 28	welding parameters .....	28, 49
starting-up .....	8, 14	welding parameters, determination of ....	26
stud feeder .....	49	welding preparation .....	26
stud welding, functional principle .....	25	welding procedure .....	28
stud welding procedure .....	22	welding process .....	8
stud welding process .....	8	welding spatters .....	28
stud welding unit .....	49	welds, high-strength .....	26
surface of welding element .....	30	work piece .....	49
surface, workpiece .....	30	working place, change of .....	17
switching off, temporary .....	36	working, start .....	38
switching off the welding gun .....	8, 36		

## T

technical data .....	8, 39
test welding .....	26
threaded stud PT .....	34
threat to life .....	8
thyristor .....	49
torque .....	27, 52
training according to current standards ..	7
transportation .....	7
transportation, packaging, storage .....	11
tripod with 3-point rest .....	44
type plate .....	12

## U

unauthorized use .....	7
user qualification, required .....	7
UT, pin .....	27, 34, 52

## V

vapors, toxic .....	14
visual inspection .....	29

## W

wear early .....	20
weld pool .....	29
welding cable .....	18
welding cable length .....	39
welding elements .....	10, 27, 34, 49





**HBS Bolzenschweiss-Systeme GmbH & Co. KG • Felix-Wankel-Strasse 18 • 85221 Dachau / Germany**  
**Phone +49 (0) 8131 511-0 • Fax +49 (0) 8131 511-100 • E-mail [post@hbs-info.com](mailto:post@hbs-info.com)**

**[www.hbs-info.com](http://www.hbs-info.com)**